

**MANUFACTURED HOME INSTALLATION MANUAL**  
**FOR MANUFACTURED HOMES PRODUCED ON OR AFTER**  
**APRIL 1, 2007**

*(Revised November 4, 2009)*  
*(Revised February 19, 2009)*  
*(Revised July 15, 2009)*

**State of Wisconsin**  
**Department of Commerce**  
**Division of Safety and Buildings**

## **Table of Contents**

<b>I. INTRODUCTION</b>	<b>3</b>
<b>II. SPECIFICATIONS</b>	<b>3</b>
<b>III. APPENDIX</b>	<b>7</b>
<b>Roof Snow Load Map</b>	<b>8</b>
<b>Draft December 8, 2005 HUD Installation Standard</b>	<b>9</b>

Published on April 3, 2007 by  
Dept. of Commerce  
Division of Safety and Buildings  
Safety and Buildings

### ADA Statement

The Department of Commerce is an equal opportunity service provider and employer. If you need assistance to access services or need material in an alternate format, please contact the Department at (608) 266-3151 or TTY (608) 264-8777.

## I. INTRODUCTION

In accordance with Comm 21.40 (1), effective April 1, 2007, the installation of a manufactured home produced on or after April 1, 2007 shall comply with procedures acceptable to the department. This manual contains a set of procedures that are acceptable to the department that addresses those items identified in Comm 21.40 (1) (b).

## II. SPECIFICATIONS

All manufactured homes manufactured on or after April 1, 2007 and installed in Wisconsin shall be installed in conformance with the provisions set forth in this manual. Installations shall conform with Housing and Urban Development (HUD) draft document, 24 CFR Part 3280 Manufactured Home Construction and Safety Standards and 24 CFR Part 3285 Model Manufactured Home Installation Standards dated December 8, 2005 as reprinted in this manual and identified in this document as “HUD Installation Standards”, subject to those changes, additions and omissions specified in this manual.

Changes or additions to or omissions from the HUD Installation Standards are specified in this manual and are requirements of the department and are not requirements of the HUD Installation Standards.

**Note:** The referenced HUD Installation Standards section number, located in brackets, will follow the manual’s number designation and title and precede the text of the manual. Example: **1. Definitions [3285.5]**.

**1. Manufacturer installation instructions [3285.2].** This is a department requirement in addition to the requirements in 3285.2: Compliance with the manufacturer installation instructions is considered compliance with HUD Installation Standards.

**2. Definitions [3285.5]. (1) ADDITIONS.** These are department definitions in addition to the definitions in 3285.5:

(a) “Department” means the department of commerce.

(b) “Manufactured home section” means a portion of a manufactured home which when installed does not provide all the facilities for year-round residential occupancy.

(c) “Manufactured home unit” means a complete manufactured home which when installed provides all the facilities for year-round residential occupancy.

(2) **SUBSTITUTIONS.** Substitute the following definitions for the corresponding definitions listed in 3285.5:

(a) “Approved” means acceptable to the department.

(b) “Base flood elevation (BFE)” means the elevation of the base flood, including wave height, relative to the datum specified on a county’s flood hazard map.

(c) “Flood hazard area” means the greater of either (1) the special flood hazard area shown on the flood insurance rate map or (2) the area subject to flooding during the design flood and shown on a county’s flood hazard map, or otherwise legally designated.

(d) “Flood hazard map” means a map delineating the flood hazard area and adopted by a county.

(e) “Local authority having jurisdiction (LAHJ)” means the department.

(f) “Manufactured home” has the meaning given in s. 101.91 (2), Stats.

**Note:** Under s.101.91 (2), Stats., "manufactured home" means any of the following:

(am) A structure that is designed to be used as a dwelling with or without a permanent foundation and that is certified by the federal department of housing and urban development as complying with the standards established under 42 USC 5401 to 5425.

(c) A mobile home, unless a mobile home is specifically excluded under the applicable statute.

**3. Fire separation distance [3285.101].** Substitute the following wording for the requirements in 3285.101: Fire separation distances shall be in accordance with s. Comm 26.12.

**4. Installation of manufactured homes in flood hazard areas [3285.102].** Substitute the following wording for the requirements in 3285.102 (c): Prior to the initial installation of a new manufactured home, the owner or permit applicant is responsible to determine whether the home site lies wholly or partly within a special flood hazard area as shown on the county’s flood insurance rate map, flood boundary and floodway map, or flood hazard boundary map. If so located, the map and supporting studies adopted by the county may be used to determine the flood hazard zone and base flood elevation at the site.

**Note:** The department of natural resources (DNR) and the federal emergency management agency (FEMA) also have regulations that apply to construction in flood hazard areas.

**5. Wind zone [3285.103 (a)].** This is a department informational note in addition to the requirements in 3285.103 (a):

**Note:** The HUD required wind loads for Wisconsin, Zone 1, are not less than 15 psf horizontal and not less than 9 psf uplift.

**6. Roof load zone [3285.103 (b)].** This is a department informational note in addition to the requirements in 3285.103 (b):

**Note:** See appendix for reprint of HUD roof load zone map.

**7. Thermal zone [3285.103 (c)].** This is a department informational note in addition to the requirements in 3285.103 (c):

**Note:** The HUD required thermal zone for Wisconsin is Zone 3, an overall maximum coefficient of heat transmission not to exceed 0.079 Btu/ (hr.) (sq. ft.) (F).

**8. Foundations – General [3285.301].** This is a department requirement in addition to the requirements in 3285.301: Footings and foundations may be designed in accordance with Subchapters IV and V of ch. Comm 21.

**9. Pier configuration – Caps and associated diagrams [3285.304 (b) (2), Fig A 3285.306, Fig. B 3285.306(b)].** Substitute the following wording for the requirements in 3285.304 (b) (2): A combination of up to two - 4” nominal thickness solid concrete blocks and no more than one 2” thick piece of hardwood lumber shall be permitted as cap material. When lumber used to fill a gap in the pier, it shall only be placed at the top of the pier. If a pier is provided with a cap block of 4” concrete or 2” lumber, a second 4” concrete block may be placed anywhere in the pier but may not be placed directly upon the footing. See Fig. 1 below.

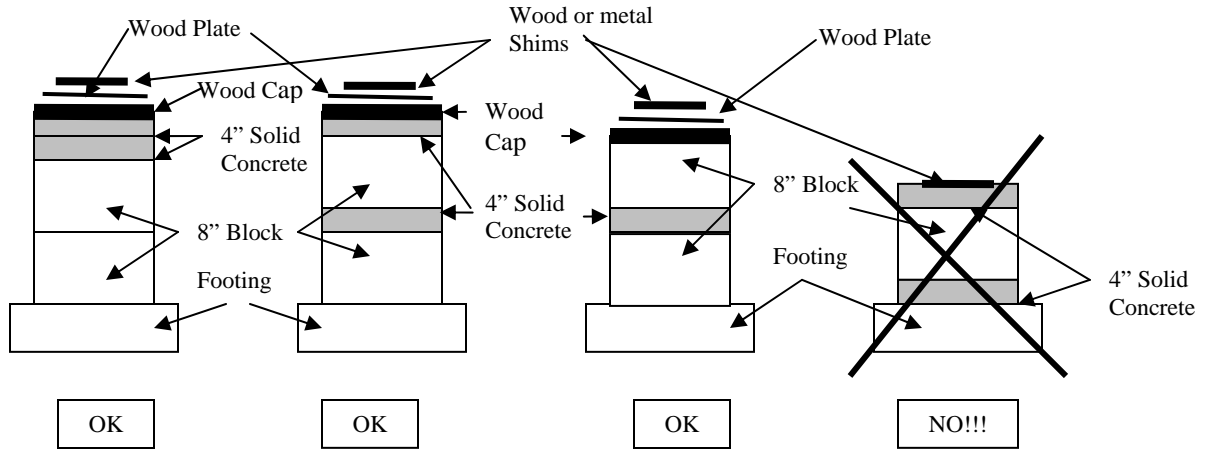

**Figure 1**  
**Pier Configuration Examples**

**10. Cap material – Caps and associated diagrams [3285.304 (b) (2), Fig A 3285.306, Fig. B 3285.306(b)].** Substitute the following wording for the requirements in 3285.304 (b) (2): Cap material may be 4 inch nominal thickness concrete or solid masonry, 2 inch minimum thickness hardwood lumber, 2 inch nominal thickness lumber at least equal to No. 2 spruce pine fir having a minimum fiber bending stress rating of 1200 psi, or one-half inch minimum thickness corrosion-protected steel. All lumber used as cap material shall be the same species of wood. See Fig. 2 below.

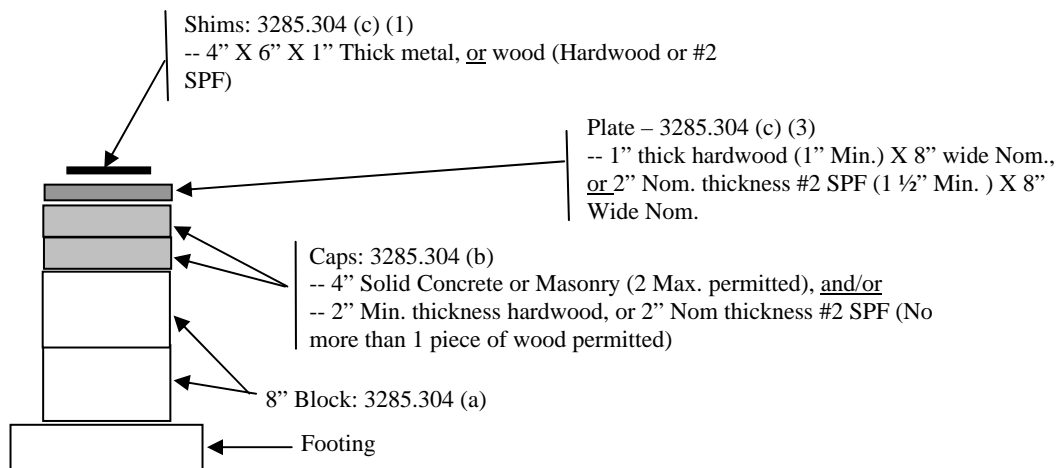

**Figure 2**  
**Pier Material**

**11. Plate material - Gaps and associated diagrams [3285.304 (c) (3), Fig A 3285.306, Fig. B 3285.306(b)].** Substitute the following wording for the requirements in

3285.304 (b) (2)(c) (3): Plate material shall be 1 inch maximum thickness hardwood lumber or 2 inch nominal thickness lumber at least equal to No. 2 spruce pine fir having a minimum fiber bending stress rating of 1200 psi. The plate material used to fill the gap shall be located at the top of the pier as shown in Fig. 2 above.

**12. Pier configuration – Shims and associated diagrams [3285.304 (c) (1), Fig A 3285.306, Fig. B 3285.306(b)].** This is a department requirement in addition to the requirements in 3285.304 (c) (1): Lumber used as shim material may be at least equal to No. 2 spruce pine fir having a minimum fiber bending stress rating of 1200 psi. All shims shall be the same species of wood. See Fig. 2 above.

**13. Placement in freezing climates [3285.312 (c)].** This is a department requirement in addition to the requirements in 3285.312 (c): Footings and foundations may be designed in accordance with Subchapters IV and V of ch. Comm 21.

**14. Ground anchor installations. [3285.402 (a) (1) & (2)].** This is a department requirement in addition to the requirements in 3285.402 (a) (1) & (2): Ground anchors and tie-down straps may be of painted steel to provide the protection against weather deterioration required by this section.

**15. Severe climate conditions [3285.404].** Substitute the following wording for the requirements in 3285.404: In frost-susceptible soil locations, ground anchor augers shall be installed to the design depth of the anchor but not less than 30 inches, unless the foundation system is frost protected to prevent the effects of frost heave in accordance with acceptable engineering practice and ss. 3280.306 and 3285.312.

**16. Crawlspace ventilation [3285.505 (d)].** Substitute the following wording for the requirements in 3285.505 (d): Ventilation openings must be covered for their full height and width with a perforated corrosion and weather resistant covering that is designed to prevent entry of rodents.

**17. Plumbing systems [3285.601].** This is a department informational note in addition to the requirements in 3285.601:

**Note:** The rules pertaining to registration and licensing of plumbers are specified in ch. Comm 5.

**18. Moving manufactured home to location [3285.902]. (1) ACCESS FOR THE TRANSPORTER [3285.902 (a)]:** Substitute the following wording for the requirements in 3285.902 (a): Before attempting to move a home, it shall be insured that the transportation equipment and home can be routed to the installation site and that all special transportation permits required by the department of transportation have been obtained.

**(2) DRAINAGE STRUCTURES [3285.902 (b)].** Substitute the following wording for the requirements in 3285.902 (b): The use of ditches and culverts to drain

surface runoff is subject to local and state regulations and shall be included and considered in the overall site preparation.

**19. Permits, alterations and on-site structures [3285.903].** Substitute the following wording for the requirements in 3285.903:

(1) ISSUANCE OF PERMITS [3285.903 (a)]. All necessary local municipality permits shall be obtained and all fees shall be paid.

(2) ALTERATIONS [3285.903 (b)]. Prior to alteration of a home installation, the local municipality shall be contacted to determine if plan approval and permits are required.

(3) INSTALLATION OF ON-SITE STRUCTURES [3285.903 (c)]. (a) Each accessory building and structure is designed to support all of its own live and dead loads, unless the structure, including any attached garage, carport, deck or porch, is attached to the manufactured home and is otherwise included in the installation instructions.

**20. Utility system connections [3285.904].** (1) PROPER PROCEDURES [3285.904 (a)]. Substitute the following wording for the requirements in 3285.904 (a): The utility provider shall be consulted before connecting the manufactured home to any utilities.

(2) CONVERSION OF GAS APPLIANCES [3285.904 (c) (1)]. Substitute the following wording for the requirements in 3285.904 (c) (1): A service person acceptable to the utility provider shall convert the appliance from one type of gas to another, following instructions by the manufacturer of each appliance.

(3) GAS APPLIANCE STARTUP PROCEDURES [3285.904 (c) (4)]. Substitute the following wording for the requirements in 3285.904 (c) (4) (intro.): When required by the utility provider, the installer shall perform the following procedures:

**21. Heating oil systems [3285.905].** This is a department informational note in addition to the requirements in 3285.905:

**Note:** See ch. Comm 10 for additional requirements relating to the installation of heating oil systems.



# **MANUFACTURED HOME INSTALLATION MANUAL**

## **APPENDIX**

**1 Roof Snow Load Map**

**2 Draft December 8, 2005 HUD Installation Standard**

# Roof Snow Load Map

24 CFR Part 3280, s. 3280.305 (c) (3)

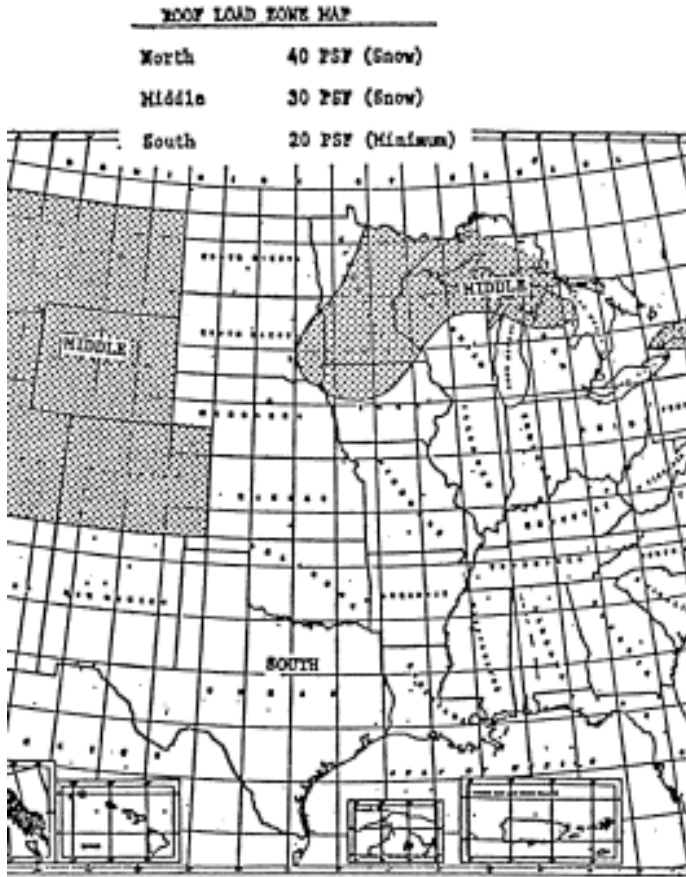

## **Draft December 8, 2005 HUD Installation Standard**

**PART 3280 MANUFACTURED HOME CONSTRUCTION AND SAFETY STANDARDS**

1. The authority citation for 24 CFR part 3280 continues to read as follows:

**Authority:** 42 U.S.C. 3535(d), 5403, 5404, and 5424.

2. In § 3280.302, add the definition of anchor assembly in alphabetical order and revise the definitions of anchoring equipment, anchoring system, diagonal tie, ground anchor and stabilizing devices to read as follows:

**§ 3280.302 Definitions.**

\* \* \* \* \*

**Anchor Assembly** means any device or other means designed to transfer home anchoring loads to the ground.

**Anchoring Equipment** means ties, straps, cables, turnbuckles, chains, and other approved components, including tensioning devices that are used to secure a manufactured home to anchor assemblies.

**Anchoring System** means a combination of anchoring equipment and anchor assemblies that will, when properly designed and installed, resist the uplift, overturning, and lateral forces on the manufactured home, and on its support and foundation system.

**Diagonal Tie** means a tie intended to resist horizontal or shear forces, but which may resist vertical, uplift, and overturning forces.

\* \* \* \* \*

**Ground Anchor** means a specific anchoring assembly device designed to transfer home anchoring loads to the ground.

\* \* \* \* \*

**Stabilizing Devices** means all components of the anchoring and support systems, such as piers, footings, ties, anchoring equipment, anchoring assemblies, or any other equipment, materials, and methods of construction that support and secure the manufactured home to the ground.

\* \* \* \* \*

3. In § 3280.306, revise paragraph (b)(2)(iii) and (iv) to read as follows:

**§ 3280.306 Windstorm protection.**

\* \* \* \* \*

(b) \* \* \*

(2) \* \* \*

(iii) That ground anchors are to be embedded below the frost line unless the foundation system is frost protected in accordance with 3285.312(c) and 3285.404 of the Model Manufactured Home Installation Standards.

(iv) That ground anchors must be installed to their full depth, and stabilizer plates must be installed in accordance with the ground anchor listing or certification to provide required resistance to overturning and sliding.

\* \* \* \* \*

4. In chapter XX, add part 3285 to read as follows:

## **PART 3285 – MODEL MANUFACTURED HOME INSTALLATION STANDARDS**

### **SUBPART A – GENERAL**

Sec.

**3285.1 Administration.**

**3285.2 Manufacturer installation instructions.**

**3285.3 Alterations during initial installation.**

**3285.4 Referenced publications.**

**3285.5 Definitions.**

**3285.6 Final leveling of manufactured home.**

### **SUBPART B – PRE-INSTALLATION CONSIDERATIONS**

**3285.101 Fire separation.**

**3285.102 Installation of manufactured homes in flood hazard areas.**

**3285.103 Design zone maps.**

**3285.104 Moving manufactured home to location.**

**3285.105 Permits, other alterations, and on-site structures.**

### **SUBPART C – SITE PREPARATION**

**3285.201 Soil conditions.**

**3285.202 Soil classifications and bearing capacity.**

**3285.203 Site Drainage.**

**3285.204 Ground moisture control.**

### **SUBPART D – FOUNDATIONS**

**3285.301 General.**

**3285.302 Flood hazard areas.**

**3285.303 Piers.**

**3285.304 Pier Configuration.**

**3285.305 Clearance under homes.**

**3285.306 Design procedures for concrete block piers.**

**3285.307 Perimeter support piers.**

**3285.308 Manufactured piers.**

**3285.309 Reserved.**

**3285.310 Pier location and spacing.**

**3285.311 Required perimeter supports.**

**3285.312 Footings.**

**3285.313 Combination systems.**

**3285.314 Reserved.**

**3285.315 Special snow load conditions.**

#### **SUBPART E – ANCHORAGE AGAINST WIND**

**3285.401 Anchoring instructions.**

**3285.402 Ground anchor installations.**

**3285.403 Sidewall, over-the-roof, mate-line, and shear wall straps.**

**3285.404 Severe climatic conditions.**

**3285.405 Severe wind zones.**

**3285.406 Flood hazard areas.**

#### **SUBPART F – OPTIONAL FEATURES**

**3285.501 Home installation manual supplements.**

**3285.502 Expanding rooms.**

**3285.503 Optional appliances.**

**3285.504 Skirting.**

**3285.505 Crawlspace ventilation.**

#### **SUBPART G – DUCTWORK AND PLUMBING AND FUEL SUPPLY SYSTEMS**

**3285.601 Field assembly.**

**3285.602 Utility connections.**

**3285.603 Water supply.**

**3285.604 Drainage system.**

**3285.605 Fuel supply system.**

**3285.606 Ductwork connections.**

#### **SUBPART H – ELECTRICAL SYSTEMS AND EQUIPMENT**

**3285.701 Electrical crossovers.**

**3285.702 Miscellaneous lights and fixtures.**

**3285.703 Smoke alarms.**

**3285.704 Telephone and cable TV.**

#### **SUBPART I – EXTERIOR AND INTERIOR CLOSE-UP**

**3285.801 Exterior close-up.**

**3285.802 Structural interconnection of multi-section homes.**

**3285.803 Interior close-up.**

**3285.804 Bottom board repair.**

#### **SUBPART J – OPTIONAL INFORMATION FOR INSTALLATION INSTRUCTIONS**

**3285.901 General.**



**3285.902 Moving manufactured home to location.**

**3285.903 Permits, alterations, and on-site structures.**

**3285.904 Utility systems connection.**

**3285.905 Heating oil systems.**

**3285.906 Telephone and cable TV.**

**3285.907 Manufacturer additions to installation instructions.**

**Authority: 42 U.S.C. 3535(d), 5403, 5404, and 5424.**

## **SUBPART A – GENERAL**

### **§ 3285.1 Administration.**

(a) **Scope.** These Model Installation Standards provide minimum requirements for the initial installation of new manufactured homes, in accordance with section 605 of the Act (42 U.S.C. 5404). The Model Installation Standards are one component of the Manufactured Housing Installation Program in part 3286 of this chapter, upon effect. Work necessary to join all sections of a multi-section home, such as work identified in subparts G, H, and I, is not considered assembly or construction of the home, although the design of those elements of a manufactured home must comply with the Manufactured Home Construction and Safety Standards (MHCSS)

(1) States that choose to operate an installation program for manufactured homes in lieu of the Federal program must implement installation standards that provide protection to its residents that equals or exceeds the protection provided by these Model Installation Standards.

(2) In States that do not choose to operate their own installation program for manufactured homes, these Model Installation Standards serve as the minimum standards for manufactured home installations.

**(b) Applicability.** The standards set forth herein have been established to accomplish certain basic objectives and are not to be construed as relieving manufacturers, retailers, installers, or other parties of responsibility for compliance with other applicable ordinances, codes, regulations, and laws. The manufactured homes covered by this standard must comply with requirements of the U.S. Department of Housing and Urban Development's (HUD's) Manufactured Home Construction and Safety Standards (MHCSS) Program, as set forth in 24 CFR part 3280, Manufactured Home Construction and Safety Standards and 24 CFR part 3282, Manufactured Home Procedural and Enforcement Regulations, as well as with, upon effect, the Manufactured Housing Installation Program, 24 CFR part 3286, and the Dispute Resolution Program, 24 CFR part 3288. The requirements of this part do not apply to homes installed on site-built permanent foundations when the manufacturer certifies the home in accordance with § 3282.12 of this chapter.

#### **§ 3285.2 Manufacturer installation instructions.**

**(a) Instructions required.** A manufacturer must provide with each new manufactured home, DAPIA-approved designs and instructions that are consistent with these Model Installation Standards for the installation of manufactured homes. The installation instructions must provide protection to residents of the manufactured homes that equals or exceeds the protection provided by these Model Installation Standards and must not take the manufactured home out of compliance with the Federal Manufactured Home Construction and Safety

Standards.

**(b) Variations to installation instructions.** When an installer does not provide support and anchorage in accordance with the approved manufacturer's installation instructions, or encounters site (such as areas that are subject to flood damage or high seismic risk) or other conditions that prevent the use of the instructions, the installer must obtain special site-specific instructions from the manufacturer or use a design by a registered professional engineer or registered architect for the support and anchorage of the manufactured home. The installation instructions must include this requirement.

**(c) Temporary storage.** The installation instructions must provide at least one method for temporarily supporting each transportable section of a manufactured home, to prevent structural and other damage to the structure, when those section(s) are temporarily sited at the manufacturer's facility, retailer's lot or the home site.

### **§ 3285.3 Alterations during initial installation.**

Additions, modifications, or replacement or removal of any equipment that affects the installation of the home made by the manufacturer, retailer or installer prior to completion of the installation by an installer must equal or exceed the protections and requirements of these Model Installation Standards, the MHCSS (24 CFR part 3280) and the Manufactured Home Procedural and Enforcement Regulations (24 CFR part 3282). An alteration, as defined in § 3282.7 of this chapter, must not affect the ability of the basic manufactured home to comply with the MHCSS and the alteration must not impose additional loads to the manufactured home or its foundation unless the alteration is included in the manufacturer's DAPIA-approved designs and installation instructions, or is designed by a registered professional engineer or architect.

**§ 3285.4 Referenced publications.**

**(a) Incorporation by reference.** (1) The specifications, standards and codes of the following organizations are incorporated by reference pursuant to 5 U.S.C. 552(a) and 1 CFR part 51 as though set forth in full. The incorporation by reference of these standards has been approved by the Director of the Federal Register. Reference standards have the same force and effect as these Model Installation Standards except that whenever reference standards and these Standards are inconsistent, the requirements of these Standards prevail to the extent of the inconsistency.

(2) The abbreviations and addresses of organizations issuing the referenced standards appear below. Reference standards that are not available from their producer organizations may be obtained from the Office of Manufactured Housing Programs, Room 9164, U.S. Department of Housing and Urban Development, 451 Seventh Street, SW; Washington, DC 20410.

**ACCA**-- Air Conditioning Contractors of America, 2800 Shirlington Road, Suite 300, Arlington, VA 22206.

ACCA Manual J, Residential Load Calculation, 8<sup>th</sup> Edition.

**APA**—The Engineered Wood Association, 7011 South 19<sup>th</sup> Street, Tacoma, Washington 98411, (253) 565-6600, fax (253) 565-7265.

PS-1-95, Construction and Industrial Plywood (with typical APA trademarks), 1995 edition.

**ASHRAE** --American Society of Heating, Refrigerating and Air Conditioning Engineers, 1791 Tullie Circle, NE, Atlanta, GA 30329–2305.

ASHRAE Handbook of Fundamentals, 1997 Inch-Pound Edition.

**ASTM** --American Society for Testing and Materials, 100 Barr Harbor Drive, West Conshohocken, PA 19428-2959.

- ASTM C 90, Standard Specification for Loadbearing Concrete Masonry Units, 2002.
- ASTM D 1586, Test Method for Penetration Test and Split-Barrel Sampling of Soils, 1999.
- ASTM D 2487, Practice for Classification of Soils for Engineering Purposes (Unified Soil Classification System), 2000.
- ASTM D 2488, Practice for Description and Identification of Soils (Visual-Manual Procedure), 2000.
- ASTM D 3953, Standard Specification for Strapping, Flat Steel and Seals, 1997.
- AWPA**--American Wood-Preservers' Association, P.O. Box 388, Selma AL 36702.
- AWPA M4-02, Standard for the Care of Pressure Treated Wood Products, 2002.
- AWPA U1-04, Use Category System; User Specification for Treated Wood, 2004.
- FEMA – Federal Emergency Management Administration, 500 C Street, SW, Washington D.C. 20472.
- FEMA 85 / September 1985, Manufactured Home Installation in Flood Hazard Areas, 1985.
- NFPA**-- National Fire Protection Association, 1 Batterymarch Park, Quincy, MA 02169-7471.
- NFPA 31, Standard for the Installation of Oil Burning Equipment, 2001.
- NFPA No.70, National Electrical Code, 2005.
- NFPA 501A, Standard for Fire Safety Criteria for Manufactured Home Installations, Sites, and Communities, 2003 Edition.
- SEI/ASCE**--Structural Engineering Institute/American Society of Civil Engineers, 1801 Alexander Bell Dr., Reston, VA 20191
- SEI/ASCE 32-01, Design and Construction of Frost Protected Shallow Foundations, 2001.
- U.L.**-- Underwriters Laboratories, 333 Pfingsten Road, Northbrook, Illinois 60062.

UL 181, Factory Made Air Ducts and Connectors, 1996 with 1998 revisions.

UL 181A, Standard for Safety Closure Systems for use with Rigid Air Ducts and Air Connectors, 1994, with 1998 revisions.

UL 181B, Standard for Safety Closure Systems for use with Flexible Air Ducts and Air Connectors, 1995, with 1998 revisions.

### **§ 3285.5 Definitions.**

The definitions contained in this section apply to the terms used in these Model Installation Standards. Where terms are not included, common usage of the terms apply. The Definitions are as follows:

**Act.** The National Manufactured Housing Construction and Safety Standards Act of 1974, 42 U.S.C. 5401-5426.

**Anchor assembly.** Any device or other means designed to transfer home anchoring loads to the ground.

**Anchoring equipment.** Ties, straps, cables, turnbuckles, chains, and other approved components, including tensioning devices that are used to secure a manufactured home to anchor assemblies.

**Anchoring system.** A combination of anchoring equipment and anchor assemblies that will, when properly designed and installed, resist the uplift, overturning, and lateral forces on the manufactured home, and on its support and foundation system.

**Approved.** When used in connection with any material, appliance or construction, means complying with the requirements of the Department of Housing and Urban Development.

**Arid region.** An area subject to 15 inches or less of annual rainfall.

**Base flood.** The flood having a one percent chance of being equaled or exceeded in any given year.

**Base flood elevation (BFE).** The elevation of the base flood, including wave height, relative to the datum specified on a LAHJ's flood hazard map.

**Comfort cooling certificate.** A certificate permanently affixed to an interior surface of the home specifying the factory design and preparations for air conditioning the manufactured home.

**Crossovers.** Utility interconnections in multi-section homes that are located where the sections are joined. Crossover connections include heating and cooling ducts, electrical circuits, and water pipes, drain plumbing, and gas lines.

**Design Approval Primary Inspection Agency (DAPIA).** A State or private organization that has been accepted by the Secretary in accordance with the requirements of part 3282, subpart H of this chapter, which evaluates and approves or disapproves manufactured home designs and quality control procedures.

**Diagonal tie.** A tie intended to resist horizontal or shear forces, but which may resist vertical, uplift, and overturning forces.

**Flood hazard area.** The greater of either: (1) the special flood hazard area shown on the flood insurance rate map; or (2) the area subject to flooding during the design flood and shown on a LAHJ's flood hazard map, or otherwise legally designated.

**Flood hazard map.** A map delineating the flood hazard area and adopted by a LAHJ.

**Footing.** That portion of the support system that transmits loads directly to the soil.

**Ground anchor.** A specific anchoring assembly device designed to transfer home anchoring loads to the ground.

**Installation instructions.** DAPIA-approved instructions provided by the home manufacturer that accompany each new manufactured home and detail the home manufacturer requirements for support and anchoring systems, and other work completed at the installation site to comply with these Model Installation Standards and the Manufactured Home Construction and Safety Standards in 24 CFR part 3280.

**Installation standards.** Reasonable specifications for the installation of a new manufactured home, at the place of occupancy, to ensure proper siting, the joining of all sections of the home, and the installation of stabilization, support, or anchoring systems.

**Labeled.** A label, symbol, or other identifying mark of a nationally recognized testing laboratory, inspection agency, or other organization concerned with product evaluation that maintains periodic inspection of production of labeled equipment or materials, and by whose labeling is indicated compliance with nationally recognized standards or tests to determine suitable usage in a specified manner.

**Listed or certified.** Included in a list published by a nationally recognized testing laboratory, inspection agency, or other organization concerned with product evaluation that maintains periodic inspection of production of listed equipment or materials, and whose listing states either that the equipment or material meets nationally recognized standards or has been tested and found suitable for use in a specified manner.

**Local authority having jurisdiction (LAHJ).** The State, city, county, city and county, municipality, utility, or organization that has local responsibilities that must be complied with during the installation of a manufactured home.

**Lowest floor.** The floor of the lowest enclosed area of a manufactured home. An unfinished or flood resistant enclosure, used solely for vehicle parking, home access or limited



storage, must not be considered the lowest floor, provided the enclosed area is not constructed so as to render the home in violation of the flood-related provisions of this standard.

**Manufactured home.** A structure, transportable in one or more sections, which in the traveling mode is 8 body feet or more in width or 40 body feet or more in length or which when erected on site is 320 or more square feet, and which is built on a permanent chassis and designed to be used as a dwelling with or without a permanent foundation when connected to the required utilities, and includes the plumbing, heating, air-conditioning, and electrical systems contained in the structure. This term includes all structures that meet the above requirements except the size requirements and with respect to which the manufacturer voluntarily files a certification pursuant to § 3282.13 of this chapter and complies with the construction and safety standards set forth in this part 3280. The term does not include any self-propelled recreational vehicle. Calculations used to determine the number of square feet in a structure will include the total of square feet for each transportable section comprising the completed structure and will be based on the structure's exterior dimensions measured at the largest horizontal projections when erected on site. These dimensions will include all expandable rooms, cabinets, and other projections containing interior space, but do not include bay windows. Nothing in this definition should be interpreted to mean that a manufactured home necessarily meets the requirements of HUD's Minimum Property Standards (HUD Handbook 4900.1) or that it is automatically eligible for financing under 12 U.S.C. 1709(b). **Manufactured Home Construction and Safety Standards** or **MHCSS**. The Manufactured Home Construction and Safety Standards established in part 3280 of this chapter pursuant to section 604 of the Act, 42 U.S.C. 5403.

**Manufactured home gas supply connector.** A listed connector designed for connecting the manufactured home to the gas supply source.

**Manufactured home site.** A designated parcel of land designed for the installation of one manufactured home for the exclusive use of the occupants of the home.

**Model Installation Standards.** The installation standards established in part 3285 of this chapter pursuant to section 605 of the Act, 42 U.S.C. 5404.

**Pier.** That portion of the support system between the footing and the manufactured home, exclusive of shims. Types of piers include, but are not limited to: (1) manufactured steel stands; (2) pressure-treated wood; (3) manufactured concrete stands; (4) concrete blocks; and (5) portions of foundation walls.

**Ramada.** Any freestanding roof or shade structure, installed or erected above a manufactured home or any portion thereof.

**Secretary.** The Secretary of Housing and Urban Development, or an official of HUD delegated the authority of the Secretary with respect to the Act.

**Skirting.** A weather-resistant material used to enclose the perimeter, under the living area of the home, from the bottom of the manufactured home to grade.

**Stabilizing devices.** All components of the anchoring and support systems, such as piers, footings, ties, anchoring equipment, anchoring assemblies, or any other equipment, materials and methods of construction, that support and secure the manufactured home to the ground.

**State.** Each of the several States, the District of Columbia, the Commonwealth of Puerto Rico, Guam, the Virgin Islands, the Canal Zone, and American Samoa.

**Support system.** Pilings, columns, footings, piers, foundation walls, shims, and any combination thereof that, when properly installed, support the manufactured home.

**Tie.** Straps, cable, or securing devices used to connect the manufactured home to anchoring assemblies.

**Ultimate load.** The absolute maximum magnitude of load that a component or system can sustain, limited only by failure.

**Utility connection.** The connection of the manufactured home to utilities that include, but are not limited to, electricity, water, sewer, gas, or fuel oil.

**Vertical tie.** A tie intended to resist uplifting and overturning forces.

**Wind Zone.** The areas designated on the Basic Wind Zone Map, as further defined in § 3280.305(c) of the Manufactured Home Construction and Safety Standards in this chapter that delineate the wind design load requirements as determined by the fastest mile wind speed (mph) within each area.

**Working load.** The maximum recommended load that may be exerted on a component or system determined by dividing the ultimate load of a component or system by an appropriate factor of safety.

**§ 3285.6 Final leveling of manufactured home.** The manufactured home must be leveled before completion of the installation.

## **SUBPART B – PRE-INSTALLATION CONSIDERATIONS**

### **§ 3285.101 Fire separation.**

Fire separation distances must be in accordance with the requirements of Chapter 6 of NFPA 501A, 2003 Edition. The installation instructions must clearly indicate this requirement in a separate section and must caution installers to take into account any local requirements on

fire separation.

**§ 3285.102 Installation of manufactured homes in flood hazard areas.**

**(a) Definitions.** Except to the extent otherwise defined in subpart A, the terms used in this subpart are as defined in 44 CFR 59.1 of the National Flood Insurance Program (NFIP) regulations.

**(b) Applicability.** The provisions of this section apply to the initial installation of new manufactured homes located wholly or partly within a flood hazard area.

**(c) Pre-installation considerations.** Prior to the initial installation of a new manufactured home, the installer is responsible to determine whether the manufactured home site lies wholly or partly within a special flood hazard area as shown on the LAHJ's Flood Insurance Rate Map, Flood Boundary and Floodway Map, or Flood Hazard Boundary Map. If so located, and before an installation method is agreed upon, the map and supporting studies adopted by the LAHJ must be used to determine the flood hazard zone and base flood elevation at the site.

**(d) General elevation and foundation requirements. (1) Methods and practices.** Manufactured homes located wholly or partly within special flood hazard areas must be installed on foundations engineered to incorporate methods and practices that minimize flood damage during the base flood, in accordance with the requirements of the LAHJ 44 CFR 60.3(a) through (e), and other provisions of 44 CFR referenced by those paragraphs.

**(2) Related guidance.** Refer to FEMA 85 /September 1985, *Manufactured Home Installation in Flood Hazard Areas, 1985*.

**§ 3285.103 Design zone maps.**

The design zone maps are those identified in part 3280 of this chapter.

**(a) Wind zone.** Manufactured homes must not be installed in a wind zone that exceeds the design wind loads for which the home has been designed as evidenced by the wind zone indicated on the home's data plate.

**(b) Roof load zone.** Manufactured homes must not be located in a roof load zone that exceeds the design roof load for which the home has been designed as evidenced by the roof load zone indicated on the home's data plate. Refer to § 3285.315 for Special Snow Load Conditions.

**(c) Thermal zone.** Manufactured homes must not be installed in a thermal zone that exceeds the thermal zone for which the home has been designed as evidenced by the thermal zone indicated on the heating/cooling certificate and insulation zone map. The manufacturer may provide the heating/cooling information and insulation zone map on the home's data plate.

#### **§ 3285.104 Moving manufactured home to location.**

Refer to § 3285.902 for considerations related to moving the manufactured home to the site of installation.

#### **§ 3285.105 Permits, other alterations, and on-site structures.**

Refer to § 3285.903 for considerations related to permitting, other alterations and on-site structures.

### **SUBPART C – SITE PREPARATION**

#### **§ 3285.201 Soil conditions.**

To help prevent settling or sagging, the foundation must be constructed on firm, undisturbed soil or fill compacted to at least 90 percent of its maximum relative density. All organic material such as grass, roots, twigs, and wood scraps must be removed in areas where footings are to be placed. After removal of organic material, the home site must be graded or otherwise prepared to ensure adequate drainage in accordance with § 3285.203.

**§ 3285.202 Soil classifications and bearing capacity.**

The soil classification and bearing capacity of the soil must be determined before the foundation is constructed and anchored. The soil classification and bearing capacity must be determined by one or more of the following methods:

**(a) Soil tests.** Soil tests that are in accordance with generally accepted engineering practice; or

**(b) Soil records.** Soil records of the applicable LAHJ; or

**(c) Soil classifications and bearing capacities.** If the soil class or bearing capacity cannot be determined by test or soil records, but its type can be identified, the soil classification, allowable pressures, and torque values shown in the following table may be used.

Soil Classification		Soil Description	Allowable Pressure (psf) <sup>1</sup>	Blow Count ASTM D1586	Torque Probe <sup>3</sup> Value <sup>4</sup> (inch-pounds)-
Classification Number	ASTM D2487 or D2488				
1	-	Rock or hard pan	4000+	-	-
2	GW, GP, SW, SP, GM, SM	Sandy gravel and gravel; very dense and/or cemented sands; coarse gravel/cobbles;	2000	40+	More than 550

		preloaded silts, clays and coral			
3	GC, SC, ML, CL	Sand; silty sand; clayey sand; silty gravel; medium dense course sands; sandy gravel; and very stiff silt, sand clays	1500	24 – 39	351 – 550
4A	CG, MH <sup>2</sup>	Loose to medium dense sands; firm to stiff clays and silts; alluvial fills	1000	18 – 23	276 – 350
4B	CH, MH <sup>2</sup>	Loose sands; firm clays; alluvial fills	1000	12 – 17	175 – 275
5	OL, OH, PT	Uncompacted fill; peat; organic clays	Refer to 3285.202(e)	0 – 11	Less than 175

Notes:

1. The values provided in this table have not been adjusted for overburden pressure, embedment depth, water table height, or settlement problems.
2. For soils classified as CH or MH, without either torque probe values or blow count test results, selected anchors must be rated for a 4B soil.
3. The torque test probe is a device for measuring the torque value of soils to assist in evaluating the holding capacity of the soil in which the ground anchor is placed. The shaft must be of suitable length for the full depth of the ground anchor.
4. The torque value is a measure of the load resistance provided by the soil when subject to the turning or twisting force of the probe.
5. An allowable pressure of 1,500 psf may be used, unless the site specific information requires the use of lower values based on soil classification and type.

**(d)** A pocket penetrometer; or

(e) If the soil appears to be composed of peat, organic clays, or uncompacted fill, or appears to have unusual conditions, a registered professional geologist, registered professional engineer, or registered architect must determine the soil classification and maximum allowable soil bearing capacity.

### **§ 3285.203 Site Drainage.**

(a) **Purpose.** Drainage must be provided to direct surface water away from the home and to prevent water build-up under the home. (b) The home site must be graded as shown in Figure 3285.203, or other methods, such as a drain tile and automatic sump pump system, must be provided to remove any water that may collect under the home.

(c) All drainage must be diverted away from the home and must slope a minimum of one-half inch per foot away from the foundation for the first 10 feet. Where property lines, walls, slopes, or other physical conditions prohibit this slope, the site must be provided with drains or swales or otherwise graded to drain water away from the structure.

(d) **Sloped site considerations.** The home, where sited, must be protected from surface runoff from the surrounding area.

(e) Refer to § 3285.902 regarding the use of drainage structures to drain surface runoff.

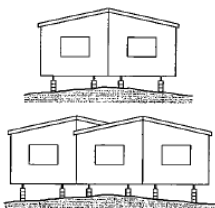

Crown and grade site to slope away from the home

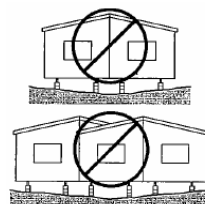

Do not grade site or set the home so water collects beneath the home.



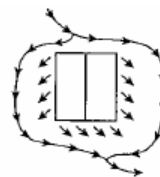
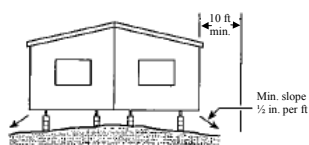

Home sites must be prepared so that there will be no depressions in which surface water may accumulate beneath the home. The area of the site covered by the manufactured home must be graded, sloped or designed to provide drainage from beneath the home or to the property line.

Natural drainage must be diverted around and away from the home.

**FIGURE 3285.203 Grading and drainage.**

**(f) Gutters and downspouts.** Manufacturers must specify in their installation instructions whether the home is designed for the installation of gutters and downspouts. When the home is so designed and gutters and downspouts are installed, the runoff must be directed away from the home.

**§ 3285.204 Ground moisture control.**

**(a) Vapor retarder.** If the space under the home is to be enclosed with skirting or other materials, a vapor retarder must be installed to cover the ground under the home, unless the home is installed in an arid region with dry soil conditions

**(b) Vapor retarder material.** A minimum of six mil polyethylene sheeting or its equivalent must be used.

**(c) Proper installation. (1)** The entire area under the home must be covered with the vapor retarder as noted in 3285.204(a) except for areas under open porches, decks, and recessed entries. Joints in the vapor retarder must be overlapped at least 12 inches and sealed.

(2) The vapor retarder may be placed directly beneath footings, or otherwise installed around or over footings placed at grade, and around anchors or other obstructions.

(3) Any voids or tears in the vapor retarder must be repaired. At least one repair method must be provided in the manufacturer's installation instructions.

## **SUBPART D – FOUNDATIONS**

### **§ 3285.301 General.**

(a) Foundations for manufactured home installations must be designed and constructed in accordance with this subpart and must be based on site conditions, home design features, and the loads the home was designed to withstand as shown on the home's data plate.

(b) Foundation systems that are not pier and footing type configurations may be used when verified by engineering data and designed in accordance with § 3285.301(d), consistent with the design loads of theMHCSS. Pier and footing specifications, that are different than those provided in this subpart, such as block size, metal piers, section width, loads, and spacing, may be used when verified by engineering data that comply with §§3285.301(c) and (d) and are capable of resisting all design loads of theMHCSS.

(c) Details, plans, and test data must be designed and certified by a registered professional engineer or registered architect, and must not take the home out of compliance with the MHCSS.

(d) **Alternative foundation systems.** Alternative foundation systems or designs are permitted in accordance with either of the following:

(1) Systems or designs must be manufactured and installed in accordance with their

listings by a nationally recognized testing agency based on a nationally recognized testing protocol; or

(2) System designs must be prepared by a registered professional engineer or a registered architect in accordance with acceptable engineering practice.

**§ 3285.302 Flood hazard areas.**

(a) In flood hazard areas, the foundation, anchorings and support systems must be capable of resisting loads associated with design flood and wind events, and homes must be installed on foundation supports that are designed and anchored to prevent floatation, collapse or lateral movement of the structure. Manufacturer's installation instructions must indicate whether:

(1) The foundation specifications have been designed and installed for flood resistant considerations, and, if so, the conditions of applicability for velocities, depths, or wave action. or,

(2) The foundation specifications are not designed to address flood loads.

**§ 3285.303 Piers.**

(a) **General.** The piers used must be capable of transmitting the vertical live and dead loads to the footings or foundation.

(b) **Acceptable piers — materials specification.** (1) Piers are permitted to be concrete blocks; pressure-treated wood with a water borne preservative, in accordance with AWPA Standard U1 for Use Category 4B ground contact applications; or adjustable metal or concrete piers.

(2) Manufactured piers must be listed or labeled for the required vertical load capacity, and, where required by design, for the appropriate horizontal load capacity.

(c) **Design requirements. (1) Load-bearing capacity.** The load bearing capacity for each pier must be designed to include consideration for the dimensions of the home, the design dead and live loads, the spacing of the piers, and the way the piers are used to support the home.

(2) Center beam/mating wall support must be required for multi-section homes and designs must be consistent with Tables 2 and 3 of this section and Figures A, B, and C to §3285.310.

(d) **Pier loads. (1)** Design support configurations and footing sizes for the pier loads, pier spacing, and roof live loads must be in accordance with Tables 1, 2, and 3 in this section and the MHCSS.. Other pier and footing designs are permitted in accordance with the provisions of this subpart.

**Table 1 to § 3285.303– Frame Blocking Only/Perimeter Support Not Required**

**Except At Openings.**

<b>Pier Spacing</b>	<b>Roof Live Load (psf)</b>	<b>Location</b>	<b>Load (lb)</b>
4 ft 0 in.	20	Frame	2900
	30	Frame	3300
	40	Frame	3600
6 ft 0 in.	20	Frame	4200
	30	Frame	4700
	40	Frame	5200
	20	Frame	5500

8 ft 0 in.	30	Frame	6200
	40	Frame	6900
10 ft 0 in.	20	Frame	6800
	30	Frame	7600
	40	Frame	8500

Notes:

1. See § 3285.312(d) for cast-in place footing design by using the noted loads.
2. Table 1 is based on the following design assumptions: maximum 16 ft. nominal section width (15 ft actual width), 12" eave, 10" I-beam size, 300 lb. pier dead load, 10 psf roof dead load, 6 psf floor dead load, 35 plf wall dead load, and 10 plf chassis dead load.
3. Interpolation for other pier spacing is permitted.
4. The pier spacing and loads shown in the above Table do not consider flood or seismic loads and are not intended for use in flood or seismic hazard areas. In those areas, the foundation support system is to be designed by a professional engineer or architect.

**Table 2 to § 3285.303 – Frame Plus Perimeter Blocking/Perimeter Blocking Required.**

Maximum Pier Spacing	Roof Live Load (psf)	Location	Load (lb)
4 ft 0 in.	20	Frame	1,400
		Perimeter	1,900
		Mating	3,200
	30	Frame	1,400
		Perimeter	2,300
		Mating	3,800
		Frame	1,400

	40	Perimeter	2,600
		Mating	4,400
6 ft 0 in.	20	Frame	1,900
		Perimeter	2,700
		Mating	4,700
	30	Frame	1,900
		Perimeter	3,200
		Mating	5,600
	40	Frame	1,900
		Perimeter	3,700
		Mating	6,500
8 ft 0 in.	20	Frame	2,400
		Perimeter	3,500
		Mating	6,100
	30	Frame	2,400
		Perimeter	4,200
		Mating	7,300
	40	Frame	2,400
		Perimeter	4,800
		Mating	8,500
10 ft 0 in.	20	Frame	2,900
		Perimeter	4,300
		Mating	7,600
	30	Frame	2,900
		Perimeter	5,100
		Mating	9,100
			Frame

	40	Perimeter	6,000
		Mating	10,600

Notes:

1. See § 3285.312(d) for cast-in place footing design by using the noted loads.
2. Mating wall perimeter piers and footings only required under full height mating walls supporting roof loads. Refer to Figures A and B in § 3285.310.
3. Table 2 is based on the following design assumptions: maximum 16 ft. nominal section width (15 ft actual width), 12" eave, 10" I-beam size, 300 lb. pier dead load, 10 psf roof dead load, 6 psf floor dead load, 35 plf wall dead load, and 10 plf chassis dead load.
4. Interpolation for other pier spacing is permitted.
5. The pier spacing and loads shown in the above Table do not consider flood or seismic loads and are not intended for use in flood or seismic hazard areas. In those areas, the foundation support system is to be designed by a professional engineer or architect.

**Table 3 to §3285.303 – Ridge Beam Span Footing Capacity.**

<b>Mating Wall Opening (ft)</b>	<b>Roof Live Load (psf)</b>	<b>Pier and Footing Load (lb)</b>
5	20	1,200
	30	1,600
	40	1,900
10	20	2,300
	30	3,100
	40	3,800
	20	3,500

15	30	4,700
	40	5,800
20	20	4,700
	30	6,200
	40	7,500
25	20	5,800
	30	7,800
	40	9,700
30	20	7,000
	30	9,300
	40	11,600
35	20	8,100
	30	10,900
	40	13,600

Notes:

1. See § 3285.312(d) for cast-in place footing design by using the noted loads.
  2. Table 3 is based on the following design assumptions: maximum 16 ft. nominal section width (15 ft actual width), 10" I-beam size, 300 lb. pier dead load, 10 psf roof dead load, 6 psf floor dead load, 35 plf wall dead load, and 10 plf chassis dead load.
  3. Loads listed are maximum column loads for each section of the manufactured home.
  4. Interpolation for maximum allowable pier and column loads is permitted for mate-line openings between those shown in the Table.
  5. The pier spacing and loads shown in the above Table do not consider flood or seismic loads and are not intended for use in flood or seismic hazard areas. In those areas, the foundation support system must be designed by a professional engineer or registered architect. **(2)**
- Manufactured piers must be rated at least to the loads required to safely support the dead and live



loads as required by § 3285.301 and the installation instructions for those piers must be consistent with Tables 1, 2 and 3 of this section.

**§ 3285.304 Pier Configuration.**

**(a) Concrete blocks.** Installation instructions for concrete block piers must be developed in accordance with the following provisions and must be consistent with Figures A and B of §3285.306.

**(1)** Load-bearing (not decorative) concrete blocks must have nominal dimensions of at least 8 inches × 8 inches × 16 inches;

**(2)** The concrete blocks must be stacked with their hollow cells aligned vertically; and

**(3)** When piers are constructed of blocks stacked side by side, each layer must be at right angles to the preceding one, as shown in Figure B of §3285.306.

**(b) Caps. (1)** Structural loads must be evenly distributed across capped hollow block piers, as shown in Figures A and B of § 3285.306.

**(2)** Caps must be solid concrete or masonry at least 4 inches in nominal thickness, or hardboard lumber at least 2 inches in thickness; or be corrosion-protected minimum one-half inch thick steel; or be of other listed materials.

**(3)** All caps must be of the same length and width as the piers on which they rest.

**(4)** When split caps are used on double-stacked blocks, the caps must be installed with the long dimension across the joint in the blocks below.

**(c) Gaps.** Any gaps that occur during installation between the main chassis beam and foundation support system must be filled, by using one of the following methods:

**(1)** Nominal 4 inch × 6 inch x 1 inch shims are permitted to be used to level the home and

fill any gaps between the base of the main chassis beam and the top of the pier cap;

Shims must be used in pairs as shown in Figures A and B of §3285.306 and must be driven in tightly so that they do not occupy more than one inch of vertical height; or **(3)** Hardwood plates no thicker than 2 inches are used to fill in remaining vertical gaps.

**(d) Manufactured pier heights.** Manufactured pier heights must be selected so that the adjustable risers do not extend more than 2 inches when finally positioned.

### **§ 3285.305 Clearance under homes.**

A minimum clearance of 12 inches must be maintained between the lowest member of the main frame (I-beam or channel beam) and the grade under all areas of the home.

### **§ 3285.306 Design procedures for concrete block piers.**

**(a) Frame piers less than 36 inches high. (1)** Frame piers less than 36 inches high are permitted to be constructed of single, open, or closed-cell concrete blocks, 8 inches × 8 inches × 16 inches, when the design capacity of the block is not exceeded.

**(2)** The frame piers must be installed so that the long sides are at right angles to the supported I-beam, as shown in Figure A of this section.

**(3)** The concrete blocks must be stacked with their hollow cells aligned vertically and must be positioned at right angles to the footings.

**(4)** Horizontal offsets from the top to the bottom of the pier must not exceed one-half inch.

**(5)** Mortar is not required unless specified in the installation instructions or required by a

registered professional engineer or registered architect.

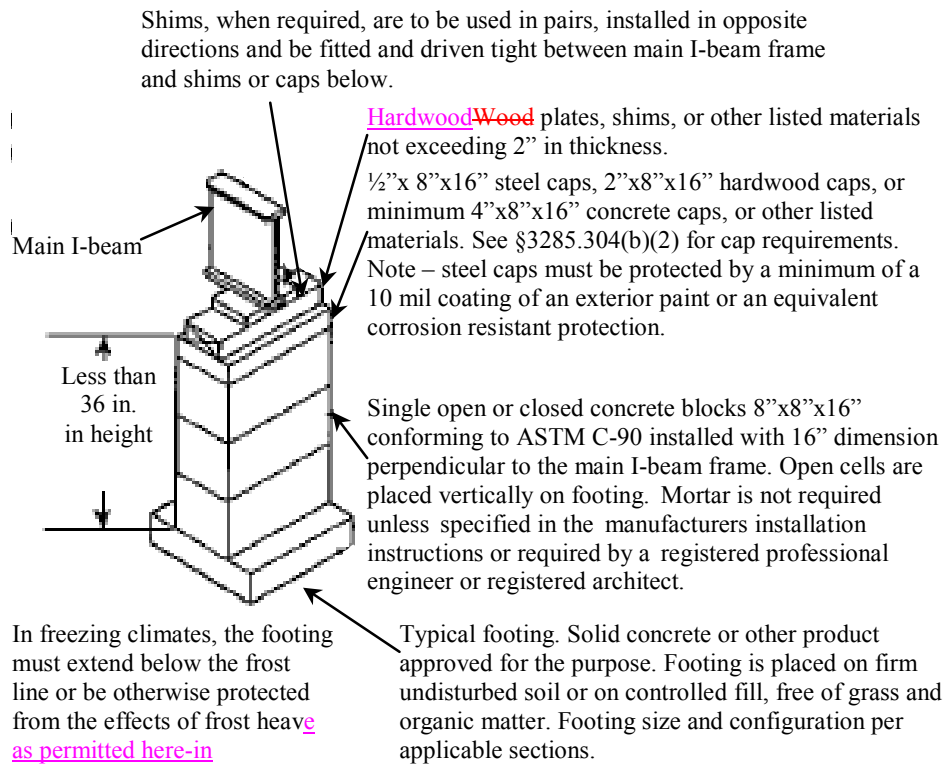
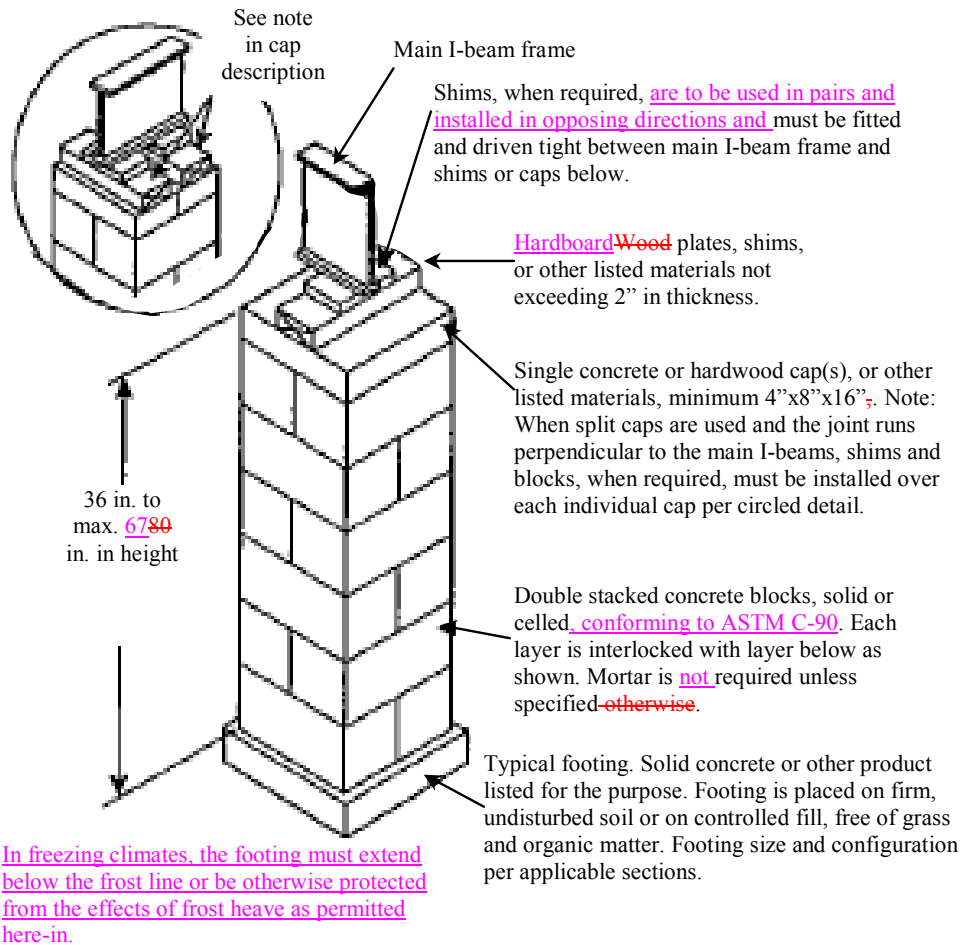

**Figure A §3285.306 Typical Footing and Pier Design, Single Concrete Block.**

**(b) Frame piers 36 inches to 67 inches high and corner piers.**

(1) All frame piers between 36 inches and 67 inches high and all corner piers over three blocks high must be constructed out of double, interlocked concrete blocks as shown in Figure B of this section, when the design capacity of the block is not exceeded. Mortar is not required for concrete block piers unless otherwise specified in the installation instructions.

(2) Horizontal offsets from the top to the bottom of the pier must not exceed one inch.



**Figure B to 3285.306(b) Typical Footing and Pier Installation, Double Concrete Block.**

(c) **All piers over 67 inches high.** Piers over 67 inches high must be designed by a registered professional engineer or registered architect in accordance with acceptable engineering practice. Mortar is not required for concrete block piers unless otherwise specified by the design.

**§ 3285.307 Perimeter support piers.**

(a) Piers required at mate-line supports, perimeter piers, and piers at exterior wall openings are permitted to be constructed of single open-cell or closed-cell concrete blocks, with

nominal dimensions of 8 inches × 8 inches × 16 inches, to a maximum height of 54 inches, as shown in Figure A of this section, when the design capacity of the block is not exceeded.

(b) Piers used for perimeter support must be installed with the long dimension parallel to the perimeter rail.

**§ 3285.308 Manufactured piers.**

Manufactured piers must be listed and labeled and installed to the pier manufacturer installation instructions. See § 3285.303(d)(2) for additional requirements.

**§ 3285.309 Reserved.**

**§ 3285.310 Pier location and spacing.**

(a) The location and spacing of piers depends upon the dimensions of the home, the live and dead loads, the type of construction (single- or multi-section), I-beam size, soil bearing capacity, footing size, and such other factors as the location of doors or other openings.

(b) Mate-line and column pier supports must be in accordance with this subpart and consistent with Figures A through C of this section.

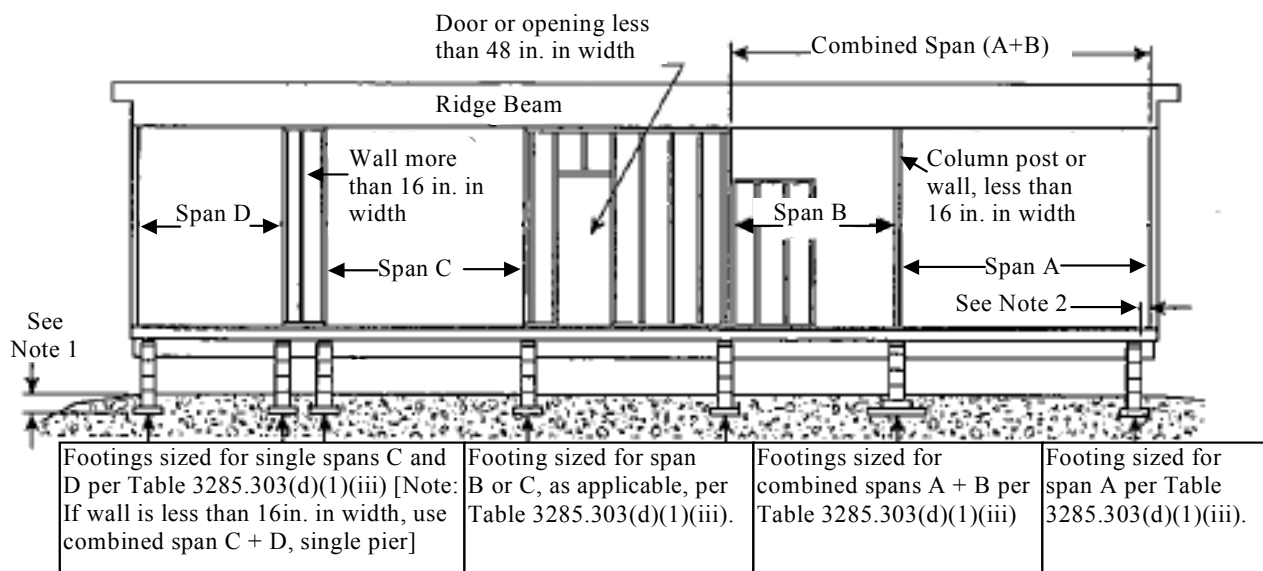

## Notes:

1. Bottom of footings must extend below frost line depth unless designed for placement above the frost line (see § 3285.312(c)).
2. Piers may be offset up to 6 in. in either direction along the supported members to allow for plumbing, electrical, mechanical, equipment, crawlspaces, or other devices.
3. Single stack concrete block pier loads must not exceed 8,000 lbs.
4. Prefabricated piers must not exceed their approved or listed maximum vertical or horizontal design loads.
5. When a full-height mating wall does not support the ridge beam, this area is considered an unsupported span – Span B.
6. Piers are not required at openings in the mating wall that are less than 48 inches in width. Place piers on both sides of mating wall openings that are 48 inches or greater in width. For roof loads of 40 psf or greater, a professional engineer or registered architect must determine the maximum mating wall opening permitted without pier or other supports.

**Figure A to § 3285.310 Typical Mate-Line Column Pier and Mating Wall Support when Frame Only Blocking is Required.**

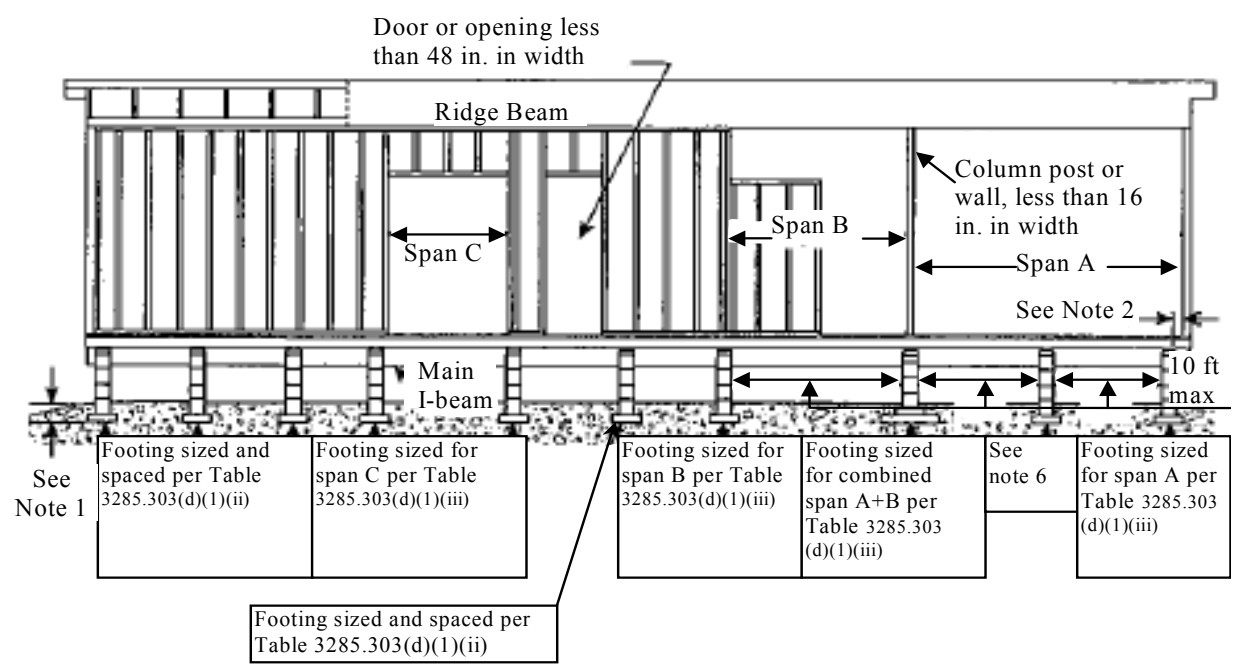

Notes:

1. Bottom of footings must be below the frost line depth unless designed for placement above the frost line. (see § 3285.312(c)).
2. Piers may be offset 6 in. in either direction along supported members to allow for plumbing electrical, mechanical equipment, crawlspaces, or other devices.
3. Single stack concrete block pier loads must not exceed 8,000 lbs.
4. Piers are not required at openings in the mating wall that are less than 48 inches in width. Place piers on both sides of mating wall openings that are 48 inches or greater in width. For roof loads of 40 psf or greater, a professional engineer or registered architect must determine the maximum mating wall opening permitted without pier or other supports.
5. When a full-height mating wall does not support the ridge beam, this area is considered an unsupported span – Span B.
6. In areas where the open span is greater than 10 ft., intermediate piers and footings must be placed at maximum 10 ft. on center.

7. Prefabricated piers must not exceed their approved or listed maximum horizontal or vertical design loads.
8. Column piers are in addition to piers required under full-height mating walls.

**Figure B to § 3285.310(b) Typical Mate-Line Column Pier and Mating Wall Support When Perimeter Blocking is Required.**

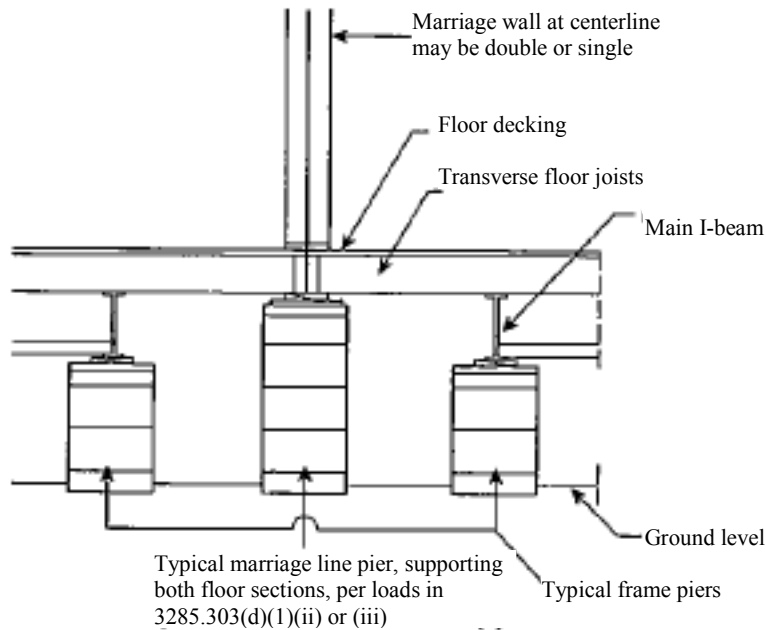

Notes:

1. Mate-line column support piers are installed with the long dimension of the concrete block perpendicular to the rim joists.
2. Pier and footing designed to support both floor sections. Loads as listed in Table 3 to § 3285.303 are total column loads for both sections.

**Figure C to § 3285.310 Typical Mate-Line Column and Piers.**

**(c)** Piers supporting the frame must be no more than 24 inches from both ends and not more than 120 inches center to center under the main rails.

**(d) Pier support locations.** Pier support locations and spacing must be presented to be consistent with Figures A and B in § 3285.312, as applicable, unless alternative designs are



provided by a professional engineer or registered architect in accordance with acceptable engineering practice.

**§ 3285.311 Required perimeter supports.**

(a) Perimeter pier or other supports must be located as follows:

(1) On both sides of side wall exterior doors (such as entry, patio, and sliding glass doors) and any other side wall openings of 48 inches or greater in width, and under load-bearing porch posts, factory installed fireplaces, and wood stoves).

(2) Other perimeter supports must be:

(i) Located in accordance with Table 2 to §3285.303; or

(ii) Provided by other means such as additional outriggers or floor joists. When this alternative is used, the designs required by § 3285.301 must consider the additional loads in sizing the pier and footing supports under the main chassis beam.

(b) For roof live loads of 40 psf or greater, a professional engineer or architect must determine the maximum sidewall opening permitted without perimeter pier or other supports.

**§ 3285.312 Footings.**

(a) Materials approved for footings must provide equal load-bearing capacity and resistance to decay as required by this section. Footings must be placed on undisturbed soil or fill compacted to 90 percent of maximum relative density. A footing must support every pier.

Required perimeter support (see note 4)

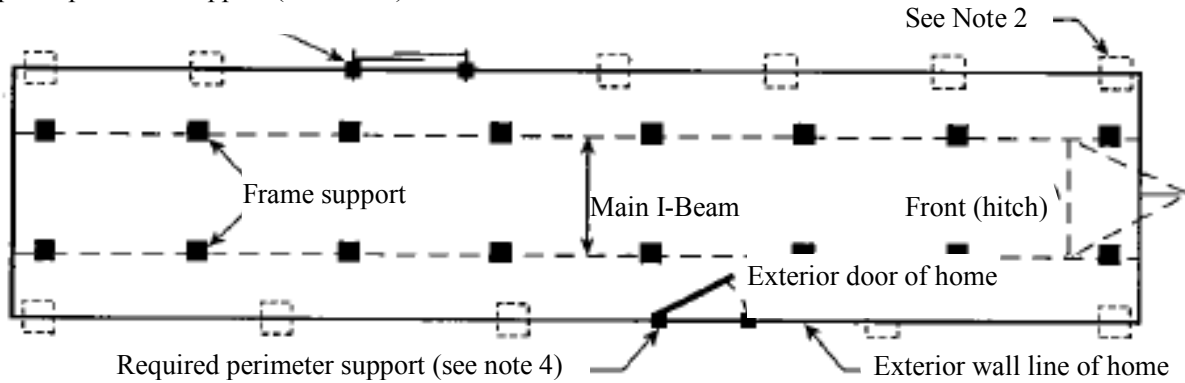

Notes:

1. Refer to table 1 of § 3285.303 for pier and footing requirements when frame blocking only is used.
2. In addition to blocking required by §3285.311, see Table 2 of §3285.303 for maximum perimeter blocking loads.
3. End piers under main I-beams may be set back a maximum of 24 in. as measured from the outside edge of the floor to the center of the pier.
4. Place piers on both sides of sidewall exterior doors, patio doors, and sliding glass doors; under porch posts, factory-installed fireplaces, and wood stoves; under jamb studs at multiple window openings; and at any other sidewall openings 48 inches or greater in width. For roof loads of 40 psf or greater, a professional engineer or registered architect must determine the maximum sidewall opening permitted without perimeter supports. See §§ 3285.307 and 3285.311 for additional requirements and for locating perimeter supports..

**Figure A to § 3285.312 Typical Blocking Diagram for Single Section Homes**

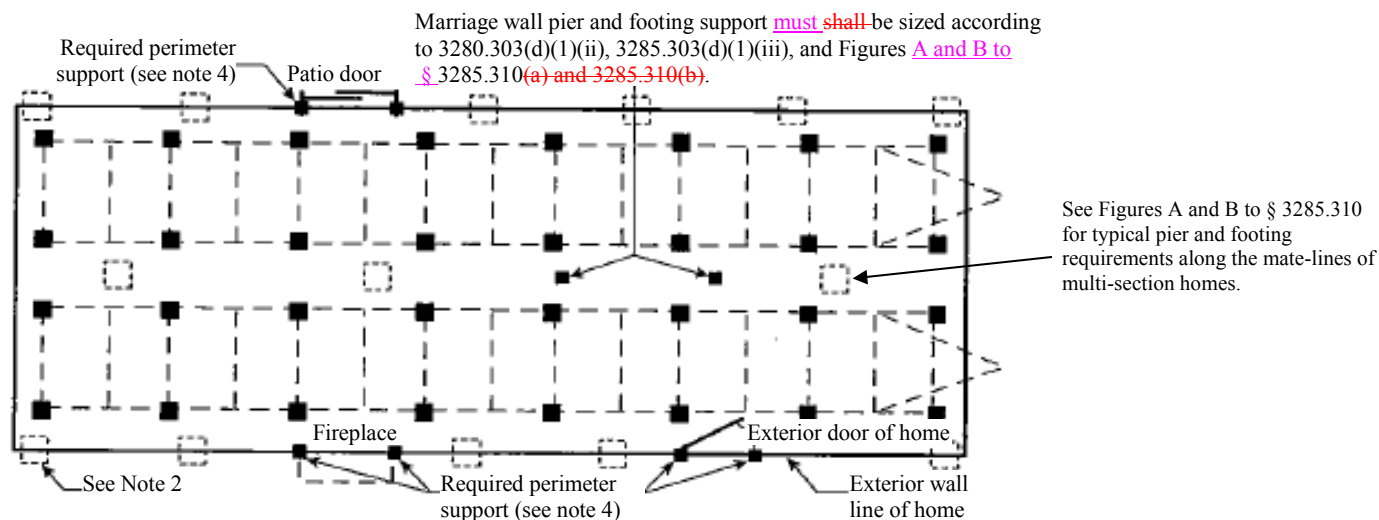

Notes:

1. Refer to Table 1 to § 3285.303 for pier and footing requirements when frame blocking only is used.
2. In addition to blocking required by § 3285.311, see Tables 2 and 3 of § 3285.303 for maximum perimeter blocking loads.
3. End piers under main I-beams may be set back a maximum of 24 in. as measured from the outside edge of the floor to the center of the pier.
4. Place piers on both sides of sidewall exterior doors, patio doors, and sliding glass doors; under porch posts, factory-installed fireplaces, and wood stoves; under jamb studs at multiple window openings; and at any other sidewall openings of 48 inches or greater in width. For roof loads of 40 psf or greater, a professional engineer or registered architect must determine the maximum side wall opening permitted without perimeter supports or mating wall opening permitted without pier or other supports. See §§ 3285.307 and 3285.311 for additional information on requirements and for locating perimeter supports.
5. When an end pier under the mate-line also serves as a column pier, it may be set back a maximum of 6 in. as measured from the inside edge of the exterior wall to the center of the pier.

**Figure B to § 3285.312 Typical Blocking Diagram for Multi-section Home.**

**(b) Acceptable types of footings. (1) Concrete.** Footings are to be either:

(i) 4-inch nominal precast concrete pads meeting or exceeding ASTM C 90–02, *Standard Specification for Load Bearing Concrete Masonry Units*, without reinforcement, with at least a 28-day compressive strength of 1,200 pounds per square inch (psi); or

(ii) 6-inch minimum poured-in-place concrete pads, slabs, or ribbons with at least a 28-day compressive strength of 3,000 pounds per square inch (psi). Cast-in-place concrete footings may also require reinforcing steel based on acceptable engineering practice, the design loads, and site specific soil conditions.

**(2) Pressure-treated wood.**

(i) Pressure-treated wood footings must consist of a minimum of two layers of nominal 2 inch thick pressure-treated wood, a single layer of nominal  $\frac{3}{4}$ -inch thick pressure-treated plywood with a maximum size of 16 inches by 16 inches, or at least two layers of  $\frac{3}{4}$ -inch thick pressure-treated plywood for sizes greater than 16 inches by 16 inches. Plywood used for this purpose is to be rated exposure 1 or exterior sheathing in accordance with PS-1-95, Construction and Industrial Plywood.

(ii) Pressure treated lumber is to be treated with a water-borne adhesive in accordance with AWPA Standard U1-04 for Use Category 4B ground contact applications.

(iii) Cut ends of pressure treated lumber must be field treated in accordance with AWPA Standard M4-02.

**(3) ABS footing pads. (i)** ABS footing pads are permitted provided they are installed in accordance with the pad manufacturer installation instructions and certified for use in the soil classification at the site.

(ii) ABS footing pads must be listed or labeled for the required load capacity.

**(c) Placement in freezing climates.** Footings placed in freezing climates must be designed using methods and practices that prevent the effects of frost heave by one of the following methods:

**(1) Conventional footings.** Conventional footings must be placed below the frost line depth for the site unless an insulated foundation or monolithic slab is used (refer to §§ 3285.312(c)(2) and 3285.312(c)(3)). When the frost line depth is not available from the LAHJ, a registered professional engineer, registered architect, or registered geologist must be consulted to determine the required frost line depth for the manufactured home site.

**(2) Monolithic slab systems.** A monolithic slab is permitted above the frost line when all relevant site-specific conditions including soil characteristics, site preparation, ventilation, and insulative properties of the underfloor enclosure are considered and the monolithic slab system is designed by a registered professional engineer or registered architect:

- (i) In accordance with acceptable engineering practice to prevent the effects of frost heave ;or
- (ii) In accordance with ASCE/SEI 32-01. The design must accommodate the anchorage requirements set out in § 3285.401.

**(3) Insulated foundations.** An insulated foundation is permitted above the frost line, when all relevant site-specific conditions including soil characteristics, site preparation, ventilation, and insulative properties of the underfloor enclosure are considered and the foundation is designed by a registered professional engineer or registered architect:

- (i) In accordance with acceptable engineering practice to prevent the effects of frost heave;or

(ii) In accordance with ASCE/SEI 32-01.

**(d) Sizing of footings.** The sizing of footings depends on the load-bearing capacity of the soil, footings, and the piers.. See §§ 3285.202, 3285.303 and 3285.312(e).

**(e) The Size and capacity for unreinforced cast-in-place footings**

		8 in. × 16 in. Pier		16 in. × 16 in. Pier	
Soil Capacity (psf)	Minimum Footing Size (in.)	Maximum Footing Capacity (lb)	Unreinforced Cast-in-Place Minimum Thickness (in.)	Maximum Footing Capacity (lb)	Unreinforced Cast-in-Place Minimum Thickness (in.)
1,000	16 × 16	1,600	6	1,600	6
	20 × 20	2,600	6	2,600	6
	24 × 24	3,700	6	3,700	6
	30 × 30	5,600	8	5,800	6
	36 × 36	7,900	10	8,100	8
	42 × 42	10,100 <sup>4</sup>	12	10,700	10
	48 × 48	13,000 <sup>4</sup>	15	13,600	12
1,500	16 × 16	2,500	6	2,500	6
	20 × 20	4,000	6	4,000	6
	24 × 24	5,600	8	5,700	6
	30 × 30	8,600 <sup>4</sup>	10	8,900	6
	36 × 36	12,200 <sup>4</sup>	12	12,600	8
	42 × 42	16,100 <sup>4</sup>	15	16,500 <sup>4</sup>	12
	48 × 48	20,400 <sup>4</sup>	18	21,000 <sup>4</sup>	15

2,000	16 × 16	3,400	6	3,400	6
	20 × 20	5,300	6	5,300	6
	24 × 24	7,600	8	7,700	6
	30 × 30	11,600 <sup>4</sup>	10	11,900	8
	36 × 36	16,300 <sup>4</sup>	15	16,900 <sup>4</sup>	10
	42 × 42	21,700 <sup>4</sup>	18	22,700 <sup>4</sup>	12
2,500	16 × 16	4,300	6	4,300	6
	20 × 20	6,700	6	6,700	6
	24 × 24	9,600 <sup>4</sup>	8	9,700	6
	30 × 30	14,700 <sup>4</sup>	12	15,000	8
	36 × 36	20,800 <sup>4</sup>	15	21,400 <sup>4</sup>	10
3,000	16 × 16	5,200	6	5,200	6
	20 × 20	8,100 <sup>4</sup>	8	8,100	6
	24 × 24	11,500 <sup>4</sup>	10	11,700	6
	30 × 30	17,800 <sup>4</sup>	12	18,100 <sup>4</sup>	8
	36 × 36	25,000 <sup>4</sup>	18	25,700 <sup>4</sup>	12
4,000	16 × 16	7,000	6	7,000	6
	20 × 20	10,800	8	10,900	6
	24 × 24	15,500 <sup>4</sup>	10	15,600	8
	30 × 30	23,800 <sup>4</sup>	15	24,200 <sup>4</sup>	10

## Notes:

1. The footing sizes shown are for square pads and are based on the area (in.<sup>2</sup>), shear, and bending required for the loads shown. Other configurations, such as rectangular or circular configurations, can be used, provided the area and depth is equal to or greater than the area and depth of the square footing shown in the table, and the distance from the edge of the pier to the edge of the footing is not less than the thickness of the footing.
2. The 6 in. cast-in-place values can be used for 4 in. unreinforced precast concrete footings.
3. The capacity values listed have been reduced by the dead load of the concrete footing.

4. Concrete block piers must not exceed their design capacity of 8,000 lbs. for 8"x16" single stack block and 16,000 lbs for 16"x16" double stacked block..

**§ 3285.313 Combination systems.**

Support systems that combine both load-bearing capacity and uplift resistance must also be sized and designed for all applicable design loads.

**§ 3285.314 Reserved.**

**§ 3285.315 Special snow load conditions.**

(a) In general, foundations for homes designed for and located in areas with roof live loads greater than 40 psf must be designed by the manufacturer for the special snow load conditions in accordance with acceptable engineering practice. Where site or other conditions prohibit the use of the manufacturer's instructions, a registered professional engineer or registered architect must design the foundation for the special snow load conditions.

(b) **Ramadas.** Ramadas may be used in areas with roof live loads greater than 40 psf. Ramadas are to be self- supporting except that any connection to the home must be for weatherproofing only.

**SUBPART E – ANCHORAGE AGAINST WIND**

**§ 3285.401 Anchoring instructions.**

(a) After blocking and leveling, the manufactured home must be secured against the wind by use of anchor assembly type installations or by connecting the home to the alternative



foundation system. See § 3285.301.

**(b)** For anchor assembly type installations, the installation instructions must require the home to be secured against the wind as described in this section. The installation instructions and design for anchor type assemblies must be prepared by a registered professional engineer or registered architect in accordance with acceptable engineering practice, the design loads of the MHCSS and § 3285.301(d).

**(c)** All anchoring and foundation systems must be capable of meeting the loads that the home was designed to withstand required by part 3280, subpart D of this chapter, that the home was designed to withstand as shown on the home's data plate.

**(d)** The installation instructions are to include at least the following information and details for anchor assembly type installations:

- (1) The maximum spacing for installing diagonal ties and any required vertical ties or straps to ground anchors;
- (2) The minimum and maximum angles or dimensions for installing diagonal ties or straps to ground anchors and the main chassis members of the manufactured home;
- (3) Requirements for connecting the diagonal ties to the main chassis members of the manufactured home. If the diagonal ties are attached to the bottom flange of the main chassis beam, the frame must be designed to prevent rotation of the beam;
- (4) Requirements for longitudinal and mating wall tiedowns and anchorage;
- (5) The method of strap attachment to the main chassis member and ground anchor; including provisions for swivel-type connections;
- (6) The methods for protecting vertical and diagonal strapping at sharp corners by use of radius clips or other means; and

(7) As applicable, the requirements for sizing and installation of stabilizer plates. **§ 3285.402**

**Ground anchor installations.**

**(a) Specifications for tie-down straps and ground anchors. (1) Ground anchors.**

Ground anchors must be listed, be provided with protection against weather deterioration and corrosion at least equivalent to that provided by a coating of zinc on steel of not less than 0.30 oz/ft<sup>2</sup> of surface coated, and be capable of resisting a minimum ultimate load of 4725 lb and a working load of 3150 lb, unless reduced capacities are noted in accordance with note 11 of Table 1 of this section or note 12 of Tables 2 and 3 of this section. The ultimate load and working load of ground anchors and anchoring equipment must be determined by a registered professional engineer, registered architect, or tested by a nationally recognized third party testing agency in accordance with a nationally recognized testing protocol.

**(2) Tie-down straps.** A 1<sup>1</sup>/<sub>4</sub> inch × 0.035 in or larger steel strapping conforming to ASTM D 3953–97, *Standard Specification for Strapping, Flat Steel and Seals*, Type 1, Grade 1, Finish B, with a minimum total capacity of 4,725 pounds (lbs) and a working capacity of 3,150 pounds (lbs) must be used. The tie-down straps must be provided with protection against weather deterioration and corrosion at least equivalent to that provided by a coating of zinc on steel of not less than 0.30 oz/ft<sup>2</sup> of surface coated. Slit or cut edges of coated strapping need not be zinc coated.

**(b) Number and location of ground anchors. (1) Ground anchor and anchor strap spacing must be:**

- (i) No greater than the spacing shown in Tables 1 thru 3 of this section and Figures A and B in this section; or
- (ii) Designed by a registered engineer or architect in accordance with acceptable

engineering practice and the requirements of the MHCSS.

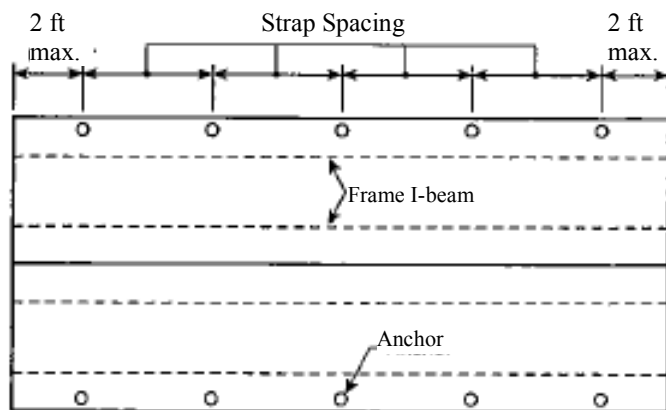

Notes:

1. Refer to Tables 1, 2 and 3 of this section for maximum ground anchor spacing.
2. Longitudinal anchors not shown for clarity, refer to 3285.402(b)(2) for longitudinal anchoring requirements.

**Figure A to §3285.402 Ground Anchor Locations and Spacing – Plan View.**

**(2) Longitudinal anchoring.** Manufactured homes must be stabilized against wind in the longitudinal direction in all Wind Zones. Manufactured homes located in Wind Zones 2 and 3 must have longitudinal ground anchors installed on the ends of the manufactured home transportable section(s) or be provided with alternative systems that are capable of resisting wind forces in the longitudinal direction.. A registered professional engineer or registered architect must design alternative longitudinal anchoring methods in accordance with acceptable engineering practice.

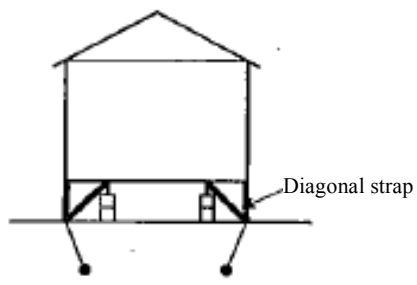

Near Beam Method

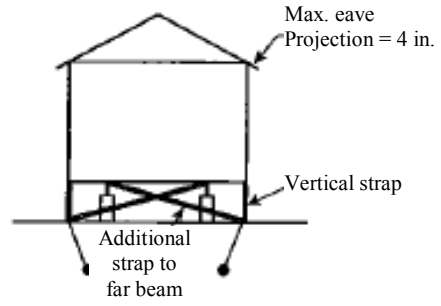

Second Beam Method

(Vertical tiedown straps required)

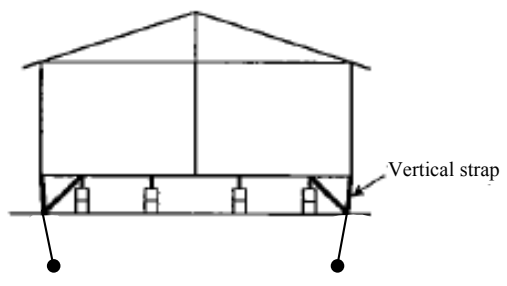

Near Beam Method

(Mate-line piers and anchors omitted for clarity)

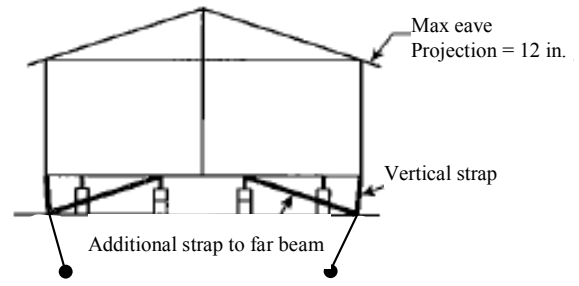

Second Beam Method

(Mate-line piers and anchors omitted for clarity)

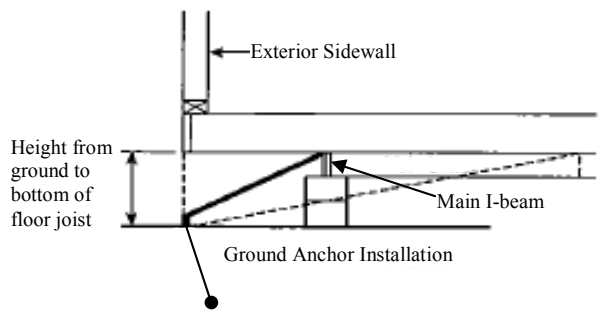

Notes:

1. Vertical Straps are not required in Wind Zone 1
2. The frame must be designed to prevent rotation of the main chassis beam, when the diagonal ties are not attached to the top flange of the beam. See § 3285.401(d)(3).

**Figure B to § 3285.402 Anchor Strap and Pier Relationship.**

(3) The requirements in § 3285.402(b)(1) must be used to determine the maximum spacing of ground anchors and their accompanying anchor straps based on the soil classification determined in accordance with § 3285.202.

(i) The installed ground anchor size (length) must be for the listed soil class. (ii) All ground anchors must be installed in accordance with their listing or certification and the ground anchor manufacturer installation instructions;

(iii) The size and type of stabilizer plate to be provided, if required by the ground anchor listing or certification. Metal stabilizer plates must be provided with protection against weather deterioration and corrosion at least equivalent to that provided by a coating of zinc on steel of not less than 0.30 oz/ft<sup>2</sup> of surface coated. Alternatively, ABS stabilizer plates may be used when listed and certified for such use.

(c) Each ground anchor must be manufactured and provided with installation instructions in accordance with its listing or certification. A nationally recognized testing agency must list, or a registered professional engineer or registered architect must certify the ground anchor for use in a classified soil (refer to § 3285.202) based on a nationally recognized testing protocol.

**Table 1 to § 3285.402– Maximum Diagonal Tiedown Strap Spacing, Wind Zone I.**

Nominal Floor Width, Single Section/Multi-section	Max. Height from Ground to Diagonal Strap Attachment	I-Beam Spacing (82.5 in. max.)	I-Beam Spacing (99.5 in. max.)
12/24 ft, 132 in. to 155 in. section(s)	25 in.	14 ft 2 in.	9 ft 9 in.
	33 in.	11 ft 9 in.	7 ft 8 in.
	46 in.	9 ft 1 in.	5 ft 8 in.
	67 in.	6 ft 6 in.	4 ft 0 in.

14/28 ft, 156 in. to 179 in. section(s)	25 in.	18 ft 2 in.	15 ft 11 in.
	33 in.	16 ft 1 in.	13 ft 6 in.
	46 in.	13 ft 3 in.	10 ft 8 in.
	67 in.	10 ft 0 in.	7 ft 9 in.
16/32 ft, 180 in. to 204 in. section(s)	25 in.	20 ft 7 in.	19 ft 5 in.
	33 in.	19 ft 0 in.	17 ft 5 in.
	46 in.	16 ft 5 in.	14 ft 7 in.
	67 in.	13 ft 1 in.	11 ft 3 in.

## Notes:

1. Table is based on maximum 90 in. sidewall height.
2. Table is based on maximum 4 in. inset for ground anchor head from edge of floor or wall.
3. Table is based on main rail (I-beam) spacing per given column.
4. Table is based on maximum 4 in. eave width for single-section homes and maximum 12 in. for multi-section homes.
5. Table is based on maximum 20-degree roof pitch (4.3/12).
6. Interpolation may be required for other heights from ground to strap attachment. The minimum height from the ground to the bottom of the floor joist must be 18 in.
7. Additional tiedowns may be required per the home manufacturer instructions.
8. Ground anchors must be certified for these conditions by a professional engineer, architect, or listed by a nationally recognized testing laboratory.
9. Ground anchors must be installed to their full depth, and stabilizer plates, if required by the ground anchor listing or certification, must be installed per the ground anchor and home manufacturer instructions.
10. Strapping and anchoring equipment must be certified by a registered professional engineer or registered architect, or listed by a nationally recognized testing agency to resist these specified forces in accordance with testing procedures in ASTM D 3953–97, *Standard Specification for Strapping, Flat Steel and Seals*.

11. A reduced ground anchor or strap working load capacity will require reduced tiedown strap and anchor spacing.

Ground anchors must not be spaced closer than the minimum spacing permitted by the listing or certification.

12. Table is based on a 3150 lb working load capacity, and straps must be placed within 2 ft of the ends of the home.

13. Table is based on a minimum angle of 30 degrees between the diagonal strap and the ground.

**Table 2 to § 3285.402– Maximum Diagonal Tiedown Strap Spacing, Wind Zone II.**

Nominal Floor Width, Single Section/ Multi- section	Max. Height from Ground to Diagonal Strap Attachment	Near Beam Method I-Beam Spacing		Second Beam Method I-Beam Spacing	
		82.5 in.	99.5 in.	82.5 in.	99.5 in.
12 ft/24 ft, 132 in. to 155 in. section(s)	25 in.	6 ft 2 in.	4 ft 3 in.	7 ft 6 in.	7 ft 7 in.
	33 in.	5 ft 2 in.	N/A	7 ft 2 in.	7 ft 4 in.
	46 in.	4 ft 0 in.	N/A	6 ft 9 in.	6 ft 11 in.
	67 in.	N/A	N/A	6 ft 1 in.	6 ft 3 in.
14 ft/28 ft, 156 in. to 179 in. section(s)	25 in.	7 ft 7 in.	6 ft 9 in.	7 ft 8 in.	7 ft 9 in.
	33 in.	6 ft 10 in.	5 ft 9 in.	7 ft 5 in.	7 ft 6 in.
	46 in.	5 ft 7 in.	4 ft 6 in.	7 ft 0 in.	7 ft 2 in.
	67 in.	4 ft 3 in.	N/A	6 ft 5 in.	6 ft 7 in.
16 ft/32 ft, 180 in. to 204 in. section(s)	25 in.	7 ft 9 in.	7 ft 10 in.	7 ft 10 in.	7 ft 10 in.
	33 in.	7 ft 6 in.	7 ft 2 in.	7 ft 7 in.	7 ft 8 in.
	46 in.	6 ft 9 in.	6 ft 0 in.	7 ft 2 in.	7 ft 3 in.
	67 in.	5 ft 4 in.	4 ft 7 in.	6 ft 8 in.	6 ft 9 in.

Notes:

1. Table is based on maximum 90 in. sidewall height.

2. Table is based on maximum 6 inch in. inset for ground anchor head from edge of floor or wall.

3. Tables is based on main rail (I-beam) spacing per given column.
4. Table is based on maximum 4 in. eave width for single-section homes and maximum 12 in. for multi-section homes.
5. Table is based on maximum 20-degree roof pitch (4.3/12).
6. All manufactured homes designed to be located in Wind Zone II must have a vertical tie installed at each diagonal tie location.
7. Interpolation may be required for other heights from ground to strap attachment. The minimum height from the ground to the bottom of the floor joist must be 18 in.
8. Additional tiedowns may be required per the home manufacturer instructions.
9. Ground anchors must be certified by a professional engineer, or registered architect, or listed by a nationally recognized testing laboratory.
10. Ground anchors must be installed to their full depth, and stabilizer plates, if required by the ground anchor listing or certification, must be installed per the ground anchor and home manufacturer instructions.
11. Strapping and anchoring equipment must be certified by a registered professional engineer or registered architect or must be listed by a nationally recognized testing agency to resist these specified forces in accordance with testing procedures in ASTM D 3953–97, *Standard Specification for Strapping, Flat Steel and Seals*.
12. A reduced ground anchor or strap working load capacity will require reduced tiedown strap and anchor spacing. Ground anchors must not be spaced closer than the minimum spacing permitted by the listing or certification.
13. Table is based on a 3150 lb working load capacity, and straps must be placed within 2 ft of the ends of the home.
14. Table is based on a minimum angle of 30 degrees between the diagonal strap and the ground.

**Table 3 to § 3285.402– Maximum Diagonal Tiedown Strap Spacing, Wind Zone III.**

Nominal Floor Width Single Section/Multi- section	Max. Height from Ground to Diagonal Strap Attachment	Near Beam Method		Second Beam Method	
		I-Beam Spacing		I-Beam Spacing	
		82.5 in.	99.5 in.	82.5 in.	99.5 in.
12 ft/24 ft 132 in. to 155 in. section(s)	25 in.	5 ft 1 in.	N/A	6 ft 1 in.	6 ft 2 in.
	33 in.	4 ft 3 in.	N/A	5 ft 10 in.	6 ft 0 in.
	46 in.	N/A	N/A	5 ft 6 in.	5 ft 8 in.



	67 in.	N/A	N/A	5 ft 0 in.	5 ft 1 in.
14 ft/28 ft 156 in. to 179 in. section(s)	25 in.	6 ft 2 in.	5 ft 7 in.	6 ft 3 in.	6 ft 4 in.
	33 in.	5 ft 8 in.	4 ft 9 in.	6 ft 0 in.	6 ft 1 in.
	46 in.	4 ft 8 in.	N/A	5 ft 8 in.	5 ft 9 in.
	67 in.	N/A	N/A	5 ft 2 in.	5 ft 4 in.
16 ft/32 ft 180 in. to 204 in. section(s)	25 in.	6 ft 4 in.	6 ft 3 in.	6 ft 4 in.	6 ft 3 in.
	33 in.	6 ft 1 in.	5 ft 11 in.	6 ft 2 in.	6 ft 2 in.
	46 in.	5 ft 7 in.	5 ft 0 in.	5 ft 10 in.	5 ft 11 in.
	67 in.	4 ft 5 in.	N/A	5 ft 5 in.	5 ft 6 in.

## Notes:

1. Table is based on maximum 90 in. sidewall height.
2. Table is based on maximum 6 inch in. inset for ground anchor head from edge of floor or wall.
3. Table is based on main rail (I-beam) spacing per given column.
4. Table is based on maximum 4 in. eave width for single-section homes and maximum 12 in. for multi-section homes.
5. Table is based on maximum 20-degree roof pitch (4.3/12).
6. All manufactured homes designed to be located in Wind Zone III must have a vertical tie installed at each diagonal tie location.
7. Interpolation may be required for other heights from ground to strap attachment. The minimum height from the ground to the bottom of the floor joist must be 18 in.
8. Additional tiedowns may be required per the home manufacturer instructions.
9. Ground anchors must be certified by a professional engineer, or registered architect, or listed by a nationally recognized testing laboratory.
10. Ground anchors must be installed to their full depth, and stabilizer plates, if required by the ground anchor listing or certification, must be installed per the ground anchor and home manufacturer instructions.

11. Strapping and anchoring equipment must be certified by a registered professional engineer or registered architect or must be listed by a nationally recognized testing agency to resist these specified forces in accordance with testing procedures in ASTM D 3953–97, *Standard Specification for Strapping, Flat Steel and Seals*.

12. A reduced ground anchor or strap working load capacity will require reduced tiedown strap and anchor spacing. Ground anchors must not be spaced closer than the minimum spacing permitted by the listing or certification.

13. Table is based on a 3150 lb working load capacity, and straps must be placed within 2 ft of the ends of the home.

14. Table is based on a minimum angle of 30 degrees between the diagonal strap and the ground.

#### **§ 3285.403 Sidewall, over-the-roof, mate-line, and shear wall straps.**

If sidewall, over-the roof, mate-line, or shear wall straps are installed on the home, they must be connected to an anchoring assembly.

#### **§ 3285.404 Severe climatic conditions.**

In frost-susceptible soil locations, ground anchor augers must be installed below the frost line unless the foundation system is frost protected to prevent the effects of frost heave in accordance with acceptable engineering practice and §§ 3280.306 and 3285.312.

#### **§ 3285.405 Severe wind zones.**

When any part of a home is installed within 1,500 feet of a coastline in Wind Zones II or III, the manufactured home must be designed for the increased requirements as specified on the home's data plate (refer to § 3280.5(f) of this chapter) in accordance with acceptable engineering practice. Where site or other conditions prohibit the use of the manufacturer's instructions, a registered professional engineer or registered architect in accordance with acceptable engineering practice must design anchorage for the special wind conditions.

#### **§ 3285.406 Flood hazard areas.**

In flood hazard areas, the piers, anchoring, and support systems must be capable of resisting all loads associated with design flood and wind events or combined flood and wind events (see § 3285.102).

## **SUBPART F – OPTIONAL FEATURES**

### **§ 3285.501 Home installation manual supplements.**

Supplemental instructions for optional equipment or features must be approved by the DAPIA as not taking the home out of conformance with the requirements of this part or part 3280 of this chapter and included with the manufacturer installation instructions.

### **§ 3285.502 Expanding rooms.**

The support and anchoring systems for expanding rooms must be installed in accordance with designs provided by the home manufacturer or prepared by a registered professional engineer or registered architect in accordance with acceptable engineering practice.

### **§ 3285.503 Optional appliances.**

**(a) Comfort cooling systems.** When not provided and installed by the home manufacturer, comfort cooling systems must be installed according to the appliance manufacturer's installation instructions.

**(1) Air conditioners.** Air conditioning equipment must be listed or certified by a nationally recognized testing agency for the application for which the unit is intended and

installed in accordance with the terms of its listing or certification (see § 3280.714 of this chapter).

**(i) Energy efficiency. (A)** Site-installed central air conditioning equipment must be sized to meet the home's heat gain requirement, in accordance with Chapter 28 of the 1997 ASHRAE Handbook of Fundamentals or ACCA Manual J, Residential Cooling Load, 8<sup>th</sup> edition.

Information necessary to calculate the home's heat gain can be found on the home's comfort cooling certificate.

**(B)** The BTU/hr rated capacity of the site-installed air conditioning equipment must not exceed the air distribution system's rated BTU/hr capacity as shown on the home's compliance certificate.

**(ii) Circuit rating.** If a manufactured home is factory provided with an exterior outlet to energize heating and/or air conditioning equipment, the branch circuit rating on the tag adjacent to this outlet must be equal to or greater than the minimum circuit amperage identified on the equipment rating plate.

**(iii) A-coil units. (A)** A-coil air conditioning units must be compatible and listed for use with the furnace in the home and installed in accordance with the appliance manufacturer's instructions.

**(B)** The air conditioner manufacturer instructions must be followed.

**(C)** All condensation must be directed beyond the perimeter of the home by means specified by the equipment manufacturer.

**(2) Heat pumps.** Heat pumps must be listed or certified by a nationally recognized testing agency for the application for which the unit is intended and installed in accordance with the terms of its listing or certification. (see § 3280.714 of this chapter).

**(3) Evaporative coolers. (i)** A roof-mounted cooler must be listed or certified by a nationally recognized testing agency for the application for which the unit is intended and installed in accordance with the terms of its listing (see § 3280.714 of this chapter).

**(A)** Any discharge grill must not be closer than three feet from a smoke alarm.

**(B)** Before field installing a roof mounted evaporative cooler, the installer must ensure that the roof will support the weight of the cooler.

**(C)** A rigid base must be provided to distribute the cooler weight over multiple roof trusses to adequately support the weight of the evaporative cooler.

**(ii)** An evaporative cooler that is not roof mounted is to be installed in accordance with the requirements of its listing or the equipment manufacturer's instructions, whichever is the more restrictive.

**(b) Fireplace and wood-stove chimneys and air inlets.** Fireplace and wood-stove chimneys and air inlets must be listed for use with manufactured homes and must be installed in accordance with their listings.

**(c) Appliance venting. (1)** All heat producing appliances except ranges and ovens must be vented to the exterior of the home.

**(2)** When the vent exhausts through the floor, the vent must not terminate under the home and must extend to the home's exterior and through any skirting that may be installed.

**(d) Flood hazard areas. (1) Outside appliances.** Appliances installed on the manufactured home site must be anchored and elevated to or above the same elevation as the lowest elevation of the lowest floor of the home.

**(2) Air inlets and exhausts.** Appliance air inlets and exhausts must be located at or above the same elevation as the lowest elevation of the lowest floor of the home.

**(e) Clothes dryer exhaust duct system.** A clothes dryer exhaust duct system must conform with and be completed in accordance with the appliance manufacturer instructions and § 3280.708 of this chapter. The vents must exhaust to the exterior of the home, beyond any perimeter skirting installed around it, as shown in Figure A of this section.

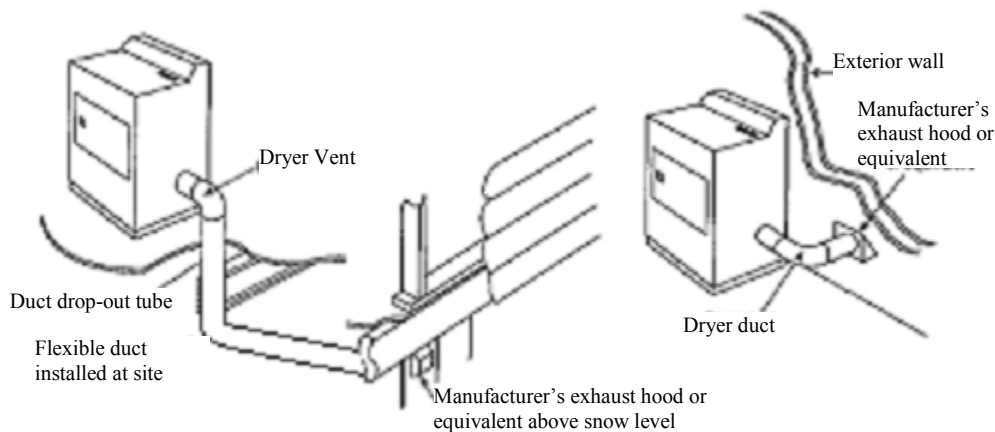

Notes:

1. Installation of the exhaust system must be in accordance with the dryer manufacturer instructions.
2. Dryer exhaust system must not contain reverse slope or terminate under the home.

**Figure A to § 3285.503 Dryer Exhaust System.**

**§ 3285.504 Skirting.**

- (a)** Skirting, if used, must be of weather-resistant materials.
- (b)** Skirting must not be attached in a manner that can cause water to be trapped between the siding and trim or forced up into the wall cavities trim to which it is attached.
- (c)** All wood skirting within 6 inches of the ground must be pressure treated in accordance with AWPAs Standard U1 for Use Category 4A, Ground Anchor Contact

Applications or be naturally resistant to decay and termite infestations.

(d) Skirting must not be attached in a manner that impedes the contraction and expansion characteristics of the home's exterior covering.

**§ 3285.505 Crawlspace ventilation.**

(a) A crawlspace with skirting must be provided with ventilation openings. The minimum net area of ventilation openings must not be less than one square foot (ft<sup>2</sup>) for every 150 square feet (ft<sup>2</sup>) of the home's floor area. The total area of ventilation openings may be reduced to one square foot (ft<sup>2</sup>) for every 1,500 square feet (ft<sup>2</sup>) of the home's floor area where a uniform 6-mil polyethylene sheet material or other acceptable vapor retarder is installed according to § 3285.204 on the ground surface beneath the entire floor area of the home.

(b) Ventilation openings must be placed as high as practicable above the ground.

(c) Ventilation openings must be located on at least two opposite sides to provide cross-ventilation.

(d) Ventilation openings must be covered for their full height and width with a perforated corrosion and weather resistant covering that is designed to prevent the entry of rodents. In areas subject to freezing, the coverings for the ventilation openings must also be of the adjustable type, permitting them to be in the open or closed position depending on the climatic conditions.

(e) Access opening(s) not less than 18 inches in width and 24 inches in height and not less than three square feet (ft<sup>2</sup>) in area must be provided and must be located so that any utility connections located under the home are accessible.

(f) Dryer vents, air conditioning condensation drains, and combustion air inlets must pass through the skirting to the outside.

## **SUBPART G – DUCTWORK AND PLUMBING AND FUEL SUPPLY SYSTEMS**

### **§ 3285.601 Field assembly.**

Home manufacturers must provide specific installation instructions for the proper field assembly of manufacturer-supplied and shipped loose ducts, plumbing, and fuel supply system parts that are necessary to join all sections of the home and are designed to be located underneath the home. The installation instructions must be designed in accordance with applicable requirements of part 3280, subparts G and H, of this chapter, as specified in this subpart.

### **§ 3285.602 Utility connections.**

Refer to § 3285.904 for considerations for utility system connections.

### **§ 3285.603 Water supply.**

**(a) Crossover.** Multi-section homes with plumbing in both sections require water-line crossover connections to join all sections of the home. The crossover must be designed in accordance with § 3280.609 of this chapter.

**(b) Maximum supply pressure and reduction.** When the local water supply pressure exceeds 80 psi to the manufactured home, a pressure-reducing valve must be installed.

**(c) Mandatory shutoff valve. (1)** An identified and accessible shutoff valve must be installed between the water supply and the inlet.

**(2)** The water riser for the shutoff valve connection must be located underneath or adjacent to the home.



(3) The shutoff valve must be a full-flow gate or ball valve, or equivalent valve.

**(d) Freezing protection.** Water line crossovers completed during installation must be protected from freezing. The freeze protection must be designed in accordance with the requirements of § 3280.603 of this chapter.

(1) If subject to freezing temperatures, the water connection must be wrapped with insulation or otherwise protected to prevent freezing.

(2) In areas subject to freezing or subfreezing temperatures, exposed sections of water supply piping, shutoff valves, pressure reducers, and pipes in water heater compartments must be insulated or otherwise protected from freezing.

**(3) Use of pipe heating cable.** Only pipe heating cable listed for manufactured home use is permitted to be used, and it must be installed in accordance with the cable manufacturer installation instructions.

**(e) Testing procedures.** (1) The water system must be inspected and tested for leaks after completion at the site. The installation instructions must provide testing requirements that are consistent with § 3280.612 of this chapter.

(2) The water heater must be disconnected when using an air-only test.

### **§ 3285.604 Drainage system.**

**(a) Crossovers.** Multi-section homes with plumbing in more than one section require drainage system crossover connections to join all sections of the home. The crossover must be designed in accordance with § 3280.610 of this chapter.

**(b) Assembly and support.** If portions of the drainage system were shipped loose because they were necessary to join all sections of the home and designed to be located underneath the home, they must be installed and supported in accordance with § 3280.608 of this chapter.

**(c) Proper slopes.** Drains must be completed in accordance with § 3280.610 of this chapter.

**(1)** Drain lines must not slope less than one-quarter inch per foot unless otherwise noted on the schematic diagram, as shown in Figure 1 to § 3285.604.

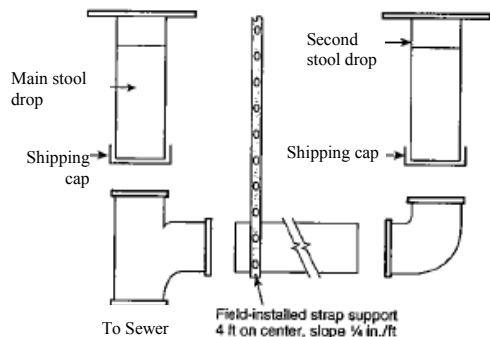

**Figure 1 to § 3285.604 Drain Pipe Slope and Connections.**

**(2)** A slope of one-eighth inch per foot may be permitted when a clean out is installed at the upper end of the run.

**(d) Testing procedures. (1)** The drainage system must be inspected and tested for leaks after completion at the site. The installation instructions must provide testing requirements that are consistent with § 3280.612 of this chapter

**§ 3285.605 Fuel supply system.**

**(a) Proper supply pressure.** The gas piping system in the home is designed for a pressure that is at least 10 inches of water column [5.8 oz./in<sup>2</sup> or 0.36 psi] and not more than 14 inches of water column [8 oz./in<sup>2</sup> or 0.5 psi]. If gas from any supply source exceeds, or could exceed this pressure, a regulator must be installed if required by the LAHJ.

**(b) Crossovers. (1)** Multi-section homes with fuel supply piping in both sections require crossover connections to join all sections of the home. The crossover must be designed in accordance with § 3280.705 of this chapter.

**(2)** Tools must not be required to connect or remove the flexible connector quick-disconnect.

**(c) Testing procedures.** The gas system must be inspected and tested for leaks after completion at the site. The installation instructions must provide testing requirements that are consistent with § 3280.705 of this chapter.

### **§ 3285.606 Ductwork connections.**

**(a) Crossovers.** Multi-section homes with ductwork in more than one section require crossover connections to complete the duct system of the home. All ductwork connections, including duct collars, must be sealed to prevent air leakage. Galvanized metal straps or tape and mastics listed to UL 181 A or UL 181 B must be used around the duct collar and secured tightly to make all connections.

**(b)** If metal straps are used, they must be secured with galvanized sheet metal screws.

**(c)** Metal ducts must be fastened to the collar with a minimum of three galvanized sheet metal screws equally spaced around the collar.

**(d)** Air conditioning or heating ducts must be installed in accordance with applicable

requirements of the duct manufacturer installation instructions.

(e) The duct must be suspended or supported above the ground by straps or other means that are spaced at a maximum distance not to exceed 4'-0" or as otherwise permitted by the installation instructions. When straps are used to support a flexible type duct, the straps must be at least 1/2" wider than the spacing of the metal spirals encasing the duct. The ducts must be installed such that the straps cannot slip between any two spirals and arranged under the floor to prevent compression or kinking in any location, as shown in Figures A and B of this section. In-floor crossover ducts are permitted in accordance with § 3285.606(g).

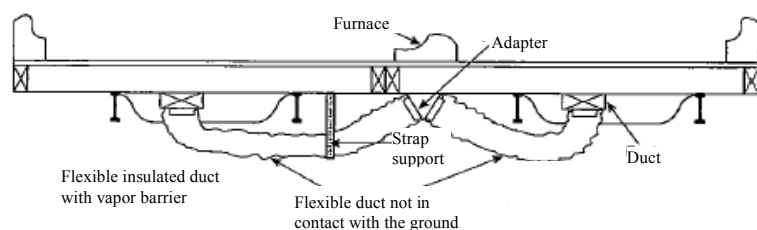

Note:

1. This system is typically used when a crossover duct has not been built into the floor and the furnace is outside the I-Beam. With this type of installation, it is necessary for two flexible ducts to be installed.
2. The crossover duct must be listed for exterior use.

**Figure A to §3285.606 Crossover Duct Installation with Two Connecting Ducts.**

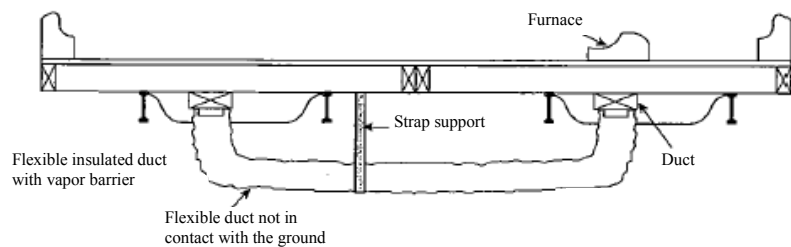

Note:

1. This system is typically used when a crossover duct has not been built into the floor and the furnace is

situated directly over the main duct in one section of the home. A single flexible duct is then used to connect the two sections to each other.

2. The crossover duct must be listed for exterior use.

### **Figure B to §3285.606 Crossover Duct Installation with one Connecting Duct.**

(f) Crossover ducts outside the thermal envelope must be insulated with materials that conform to designs consistent with part 3280, subpart F of this chapter.

(g) In-floor or ceiling crossover duct connections must be installed and sealed to prevent air leakage.

## **SUBPART H – ELECTRICAL SYSTEMS AND EQUIPMENT**

### **§ 3285.701 Electrical crossovers.**

Multi-section homes with electrical wiring in more than one section require crossover connections to join all sections of the home. The crossover must be designed in accordance with part 3280, subpart I of this chapter, and completed in accordance with the directions provided in the installation instructions.

### **§ 3285.702 Miscellaneous lights and fixtures.**

(a) When the home is installed, exterior lighting fixtures, ceiling-suspended (paddle) fans, and chain-hung lighting fixtures are permitted to be installed in accordance with their listings and part 3280, subpart I, of this chapter.

(b) **Grounding.** (1) All the exterior lighting fixtures and ceiling fans installed per

§ 3285.702(a) must be grounded by a fixture-grounding device or by a fixture-grounding wire.

(2) For chain-hung lighting fixtures, as shown in Figure A in this section, both a fixture-grounding device and a fixture-grounding wire must be used. The identified conductor must be the neutral conductor.

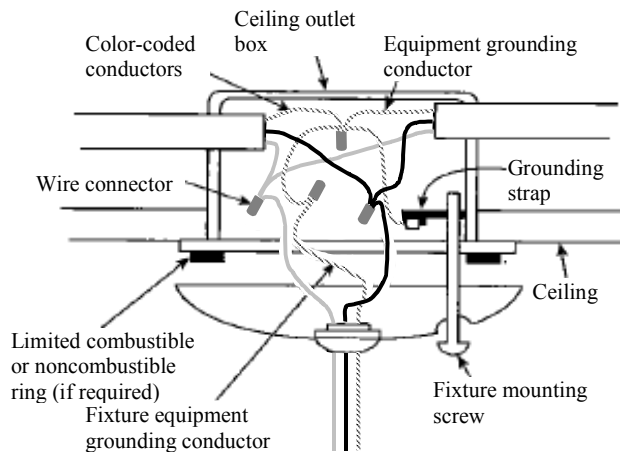

**Figure A to § 3285.702 Typical Installation of Chain-Hung Lighting Fixture.**

(b) Where lighting fixtures are mounted on combustible surfaces such as hardboard, a limited combustible or noncombustible ring, as shown in Figures A and B of this section, must be installed to completely cover the combustible surface exposed between the fixture canopy and the wiring outlet box.

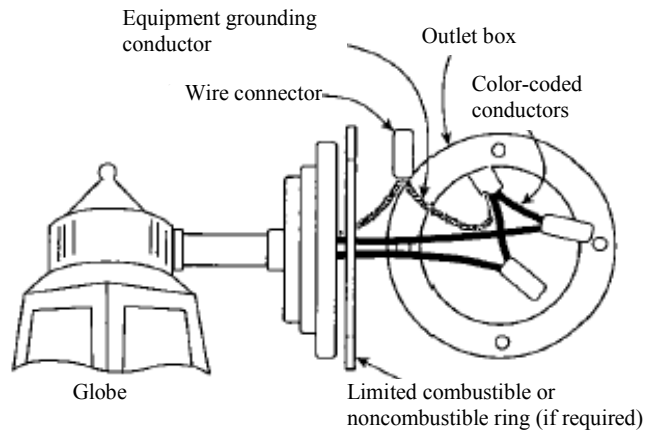

**Figure B to § 3285.702 Typical Installation of Surface-Mounted Exterior Lighting Fixture.**

- (c) Exterior lights. (1)** The junction box covers must be removed and wire-to-wire connections must be made using listed wire connectors.
- (2)** Wires must be connected black-to-black, white-to-white, and equipment ground-to-equipment ground.
- (3)** The wires must be pushed into the box, and the lighting fixture must be secured to the junction box.
- (4)** The lighting fixture must be caulked around its base to ensure a watertight seal to the sidewall.
- (5)** The light bulb must be installed and the globe must be attached.
- (d) Ceiling fans. (1)** Ceiling-suspended (paddle) fans must be connected to a junction box listed for ceiling fan application and installed with the trailing edges of the blades at least 6 feet 4 inches above the finished floor.
- (2)** The wiring must be connected in accordance with the product manufacturer installation instructions.

**(e) Testing. (1)** After completion of all electrical wiring and connections, including crossovers, electrical lights, and ceiling fans, the electrical system must be inspected and tested. The installation instructions must provide testing requirements that are consistent with § 3280.810(b) of this chapter.

**(2)** The installation instructions are to indicate that each manufactured home must be subjected to the following tests:

- (i)** An electrical continuity test to ensure that metallic parts are effectively bonded;
- (ii)** Operational tests of all devices and utilization equipment except water heaters, electric ranges, electric furnaces, dishwashers, clothes washers/dryers, and portable appliances to demonstrate that they are connected and in working order; and
- (iii)** For electrical equipment installed or completed during installation, electrical polarity checks must be completed to determine that connections have been made properly. Visual verification is an acceptable electrical polarity check.

### **§ 3285.703 Smoke alarms.**

Smoke alarms must be functionally tested in accordance with applicable requirements of the smoke alarm manufacturer instructions and must be consistent with § 3280.208 of this chapter.

### **§ 3285.704 Telephone and cable TV.**

Refer to § 3285.906 for considerations pertinent to installation of telephone and cable TV.



## SUBPART I – EXTERIOR AND INTERIOR CLOSE UP

### § 3285.801 Exterior close-up.

(a) Exterior siding and roofing necessary to join all sections of the home must be installed according to the product manufacturer installation instructions and must be fastened in accordance with designs and manufacturer instructions consistent with §§ 3280.305 and 3280.307 of this chapter. Exterior close-up strips/trim must be fastened securely and sealed with exterior sealant (see figure A of this section).

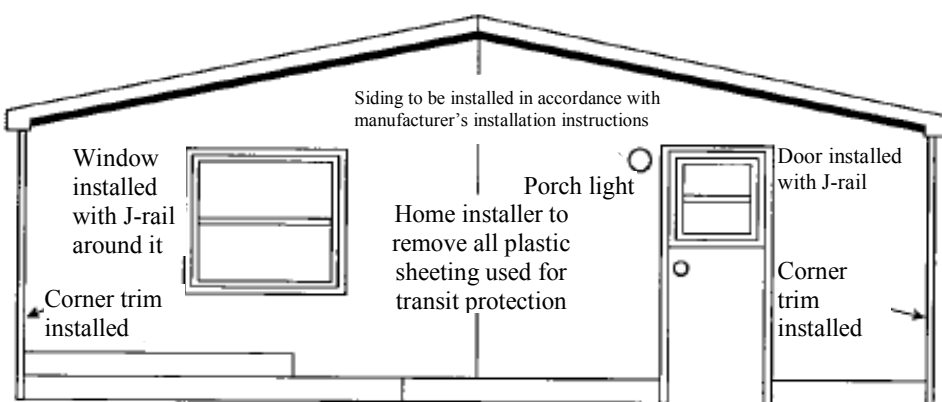

Notes:

1. Multi-section homes with horizontal-lap siding can be shipped with no siding on the front and rear end walls.
2. The manufacturer must install doors/windows trimmed with J-rail and protect all exposed materials not designed for exposure to the weather with plastic sheeting for transport. Siding, starter trim, and vents may be shipped loose in the home for installation on set up.
3. All home installers must ensure that all field installed trim, windows, doors, and other openings are properly sealed according to the siding manufacturer installation instructions.

### **FIGURE A to §3285.801 Installation of Field-Applied Horizontal Lap Siding**

(b) **Joints and seams.** All joints and seams in exterior wall coverings that were disturbed during location of the home must be made weatherproof.

(c) Prior to installing the siding, the polyethylene sheeting covering exterior walls for

transit must be completely removed.

(d) Holes in the roof made in transit or setup must be made weatherproof and sealed with a sealant or other material that is suitable for use with the roofing materials in which the hole is made. (e) **Mate-line gasket.** The home manufacturer must provide materials and designs for mate-line gaskets or other methods designed to resist the entry of air, water, water vapor, insects, and rodents at all mate-line locations exposed to the exterior (see Figure B of this section).

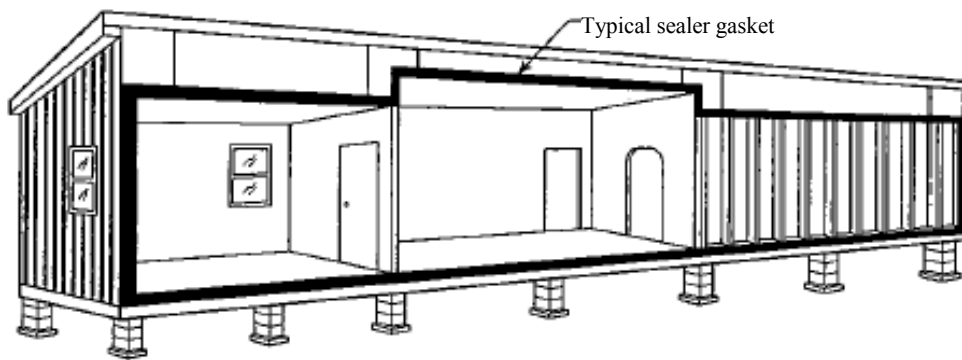

Note: On multi-section manufactured dwellings, install sealer gasket on the ceiling, end walls, and floor mate-line prior to joining the sections together.

**Figure B to § 3285.801 Mate-Line Gasket.**

(f) **Hinged roofs and eaves.** Hinged roofs and eaves must be completed during installation so as to comply with §§ 3280.305 and 3280.307 of this chapter. However, some hinged roofs may be subject to specific On-Site or Alternative Construction requirements issued separately by the Secretary. Generally, hinged roof homes are not subject to such special requirements as long as:

- (1) The homes are designed to be located in Wind Zone 1, and
- (2) The completed hinged roof pitch is less than 7 in 12, and
- (3) Fuel burning appliance flue penetrations are not above the hinge. **§ 3285.802 Structural**

**interconnection of multi-section homes.**

(a) For multi-section homes, structural interconnections along the interior and exterior at the mate-line are necessary to join all sections of the home.

(b) The interconnections must be designed in accordance with § 3280.305 of this chapter to ensure a completely integrated structure.

(c) Upon completion of the exterior close-up, no gaps are permitted between the structural elements being interconnected along the mate-line of multi-section homes. However, prior to completion of the exterior close-up, minor gaps that do not exceed one inch are permitted between structural elements provided the gaps are closed before completion of close-up, the home sections are in contact with each other, and the mating gasket is providing a proper seal. All gaps must be shimmed with dimensional lumber, and fastener lengths used to make connections between the structural elements must be increased to provide adequate penetration into the receiving member. **§ 3285.803 Interior close-up.**

(a) All shipping blocking, strapping, or bracing must be removed from appliances, windows, and doors.

(b) Interior close up items necessary to join all sections of the home or items subject to transportation damage may be packaged or shipped with the home for site installation.

(c) At a minimum, shipped-loose wall paneling necessary for the joining of all sections of the home must be installed by using polyvinyl acetate (PVA) adhesive on all framing members and fastened with minimum one-inch long staples or nails at 6 inches on center panel edges and 12 inches on center in the field, unless alternative fastening methods are required in the installation instructions (see Figure A to § 3285.803).

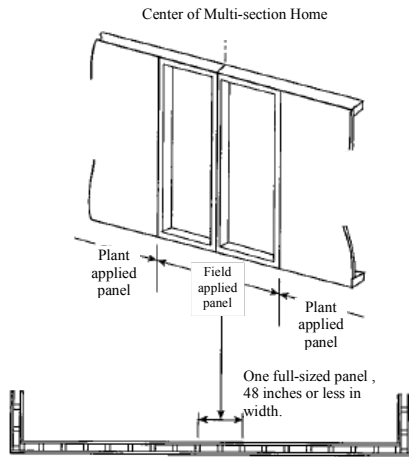

Note:

Specific designs must be approved by a DAPIA and included in the home manufacturer installation instructions.

**FIGURE A to §3285.803 - Installation of Interior Field-Applied Panels.**

**§ 3285.804 Bottom board repair.**

(a) The bottom board covering must be inspected for any loosening or areas that might have been damaged or torn during installation or transportation. Any missing insulation is to be replaced prior to closure and repair of the bottom board.

(b) Any splits or tears in the bottom board must be resealed with tape or patches in accordance with methods provided in the manufacturers installation instructions.

(c) Plumbing P-traps must be checked to be sure they are well insulated and covered.

(d) All edges of repaired areas must be taped or otherwise sealed.

**SUBPART J –OPTIONAL INFORMATION FOR INSTALLATION INSTRUCTIONS**

**§ 3285.901 General**

The planning and permitting processes as well as utility connection, access, and other requirements are outside of HUD's authority and may be governed by LAHJs. These Model Installation Standards do not attempt to comprehensively address such requirements. . However, HUD recommends that the manufacturer's installation instructions include the information and advisories in this Subpart J, in order to protect the manufactured home as constructed in accordance with the MHCSS.

**§ 3285.902 Moving manufactured home to location.**

It is recommended that the installation instructions include that the manufactured home is to be moved to the site and placed on the site only when the site is prepared in accordance with subpart C of this part and when the utilities are available as required by the LAHJ. Examples of related areas that might be addressed in the installation instructions for meeting this recommendation include:

**(a) Access for the transporter.** Before attempting to move a home, ensure that the transportation equipment and home can be routed to the installation site and that all special transportation permits required by the LAHJ have been obtained.

**(b) Drainage structures.** Ditches and culverts used to drain surface runoff meet the requirements of the LAHJ and are considered in the overall site preparation.

**§ 3285.903 Permits, alterations, and on-site structures.** It is recommended that the installation instructions include the following information related to permits, alterations, and on-site structures:

**(a) Issuance of permits.** All necessary LAHJ fees should be paid and permits should be obtained, which may include verification that LAHJ requirements regarding encroachments in streets, yards, and courts are obeyed and that permissible setback and fire separation distances from property lines and public roads are met..

**(b) Alterations.** Prior to making any alteration to a home or its installation, contact the LAHJ to determine if plan approval and permits are required.

**(c) Installation of on-site structures.** Each accessory building and structure is designed to support all of its own live and dead loads, unless the structure, including any attached garage, carport, deck, and porch, is to be attached to the manufactured home and is otherwise included in the installation instructions or designed by a registered professional engineer or registered architect.

**§ 3285.904 Utility system connections.** It is recommended that the manufacturer's installation instructions suggest that:

**(a) Proper procedures.** The LAHJ be consulted before connecting the manufactured home to any utilities, and only qualified personnel familiar with local requirements be permitted to make utility site connections and conduct tests.

**(b) Drainage system.** The main drain line be connected to the site's sewer hookup, using an elastomeric coupler or by other methods acceptable to the LAHJ, as shown in Figure A in this section.

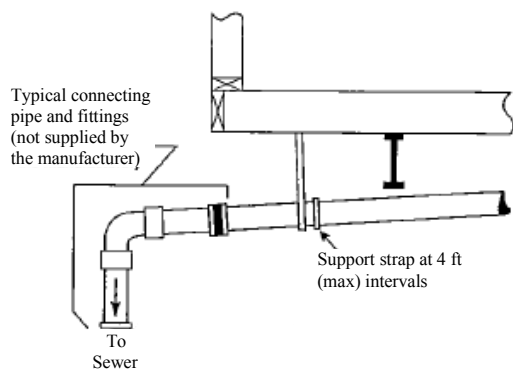

Note:

Fittings in the drainage system that are subject to freezing, such as P-traps in the floor, are protected with insulation by the manufacturer. Insulation must be replaced if it is removed for access to the P-trap.

**Figure A to § 3285.904 Connection to Site Sewer. (c) Fuel supply system. (1) Conversion of gas appliances.** A service person acceptable to the LAHJ convert the appliance from one type of gas to another, following instructions by the manufacturer of each appliance.

**(2) Orifices and regulators.** Before making any connections to the site supply, the inlet orifices of all gas-burning appliances be checked to ensure they are correctly set up for the type of gas to be supplied.

**(3) Connection procedures.** Gas-burning appliance vents be inspected to ensure that they are connected to the appliance and that roof jacks are properly installed and have not come loose during transit.

**(4) Gas appliance startup procedures.** The LAHJ should be consulted concerning the following gas appliance startup procedures:

**(i)** One at a time, opening equipment shutoff valves, lighting pilot lights when provided, and adjusting burners and spark igniters for automatic ignition systems in accordance with each appliance manufacturer instructions.

**(ii)** Checking the operation of the furnace and water heater thermostats.

**§ 3285.905 Heating oil systems.**

It is recommended that the installation instructions include the following information related to heating oil systems, when applicable:

**(a)** Homes equipped with oil burning furnaces should have their oil supply tank and piping installed and tested on site in accordance with in accordance with NFPA 31, Standard for the Installation of Oil Burning Equipment, 2001.

**(b)** or the LAHJ, whichever is more stringent.

**(b)** The oil burning furnace manufacturer's instructions should be consulted for pipe size and installation procedures.

**(c)** Oil storage tanks and pipe installations should meet all applicable local regulations.

**(d) Tank installation requirements. (1)** The tank should be located where it is accessible to service and supply and safe from fire and other hazards.

**(2)** In flood hazard areas, the oil storage tank should be anchored and elevated to or above the design flood elevation, or anchored and designed to prevent flotation, collapse, or permanent lateral movement during the design flood.



**(3) Leak test procedure.** Before the system is operated, it should be checked for leaks in the tank and supply piping in accordance with NFPA 31, Standard for the Installation of Oil Burning Equipment, 2001 or the requirements of the LAHJ, whichever is more stringent.

**§ 3285.906 Telephone and cable TV.**

It is recommended that the installation instructions explain that telephone and cable TV wiring should be installed in accordance with requirements of the LAHJ and the National Electrical Code, NFPA No.70-2005. .

**§ 3285.907 Manufacturer additions to installation instructions.** A manufacturer may include in its installation instructions items that are not required by this chapter as long as the items included by the manufacturer are consistent with the Model Installation Standards and do not take the manufactured home out of compliance with the MHCSS.

**Date:** \_\_\_\_\_

---

Brian D. Montgomery, Assistant Secretary for  
Housing-Federal Housing Commissioner

**(FR-4928-F-02)**